



Rev. B | 2018.08

LPT-P Digital Car Park Transmitter

TABLE OF CONTENTS

1 POLICIES	5
1.1 Important Note	5
1.2 Warranty Policy	6
1.3 Service Policy	6
1.4 Copyrights and Registered Trademarks	7
1.5 Disclaimer	7
1.6 Revisions	8
2 INTRODUCTION	9
2.1 General Description	9
2.2 Key Features	10
3 INSTRUMENT SPECIFICATIONS	11
3.1 Technical Specifications	11
3.2 Internal Sensor Gas Types	13
3.3 ESH-A Remote Sensor Gas Types	13
3.4 Enclosure Dimensions	14
4 INSTRUMENT FEATURES	15
4.1 Exterior Enclosure	15
4.2 Interior System Layout	17
5 INSTALLATION	18
5.1 General Safety Warnings	19
5.2 Protection Against Electrical Risks	19
5.3 Protection Against Mechanical Risks	20
5.4 Mounting the Transmitter	20
5.4.1 Wet Environment Considerations	21

5.4.2 EMI and RF Interference Considerations	21
5.4.3 Mounting Height (Sensor Dependent)	22
5.5 Enclosure Mounting Components	23
5.5.1 Enclosure Base	23
5.5.2 Enclosure Bottom	24
5.6 Wiring Connections	24
5.6.1 Power & Output Connections	25
5.6.2 ESH-A Remote Sensor Wiring Connection.....	26
5.6.3 Wire Gauge vs Run Length.....	26
6 SYSTEM OPERATION & CONFIGURATION	27
6.1 Navigating the Menu Structure	27
6.2 Accessing the Menu with Passcodes	28
6.3 Power Up and Warm-up	29
6.4 Display Select	30
6.5 Set LCD Display Contrast Level	31
6.6 Fault Detection.....	31
6.7 Modbus® Settings	32
6.7.1 Change Modbus® ID	32
6.7.2 Change Modbus® Baud Rate	33
6.7.3 Modbus® Holding Registers	34
6.8 Setting Channel Alarm Setpoints	34
6.8.1 Setting the Low Alarm Setpoint	34
6.8.2 Setting the Mid Alarm Setpoint	35
6.8.3 Setting the High Alarm Setpoint	36
6.8.4 Setting Hysteresis.....	36
6.9 Enable / Disable Channels	36
6.10 Test Gas Reading Response / Send Test Reading to Controller.....	37

7 CALIBRATION	39
7.1 Calibration Specifications.....	39
7.1.1 Gas.....	39
7.1.2 Regulators & Flow.....	39
7.1.3 Adapters.....	39
7.1.4 Calibration Frequency.....	40
7.1.5 Gas Testing Frequency (Bump Testing).....	40
7.1.6 Non-Intrusive Calibration.....	40
7.2 Calibrating the Internal Sensor(s).....	41
7.3 Troubleshooting Calibration.....	43
7.3.1 Calibration Adapter Plug.....	44
7.3.2 Zero Calibration Shift.....	44
7.3.3 Zero - Requires Override.....	44
7.3.4 Span - Requires Override.....	44
7.3.5 Fault Reading.....	45
7.3.6 Calibration Failure.....	45
7.4 Calibrating an ESH-A Remote Sensor Connected to an LPT-P.....	46
7.4.1 Zero and Span Calibration of a Responsive ESH-A Remote Sensor.....	46
7.4.2 Zero Calibration of a New or Replacement ESH-A Remote Sensor.....	46
8 ACCESSORIES	47
8.1 Splash Guard.....	48
8.2 Magnetic Wand.....	48
8.3 Metal Protective Guard.....	49
8.4 Calibration Kit.....	49
9 MAINTENANCE	50
10 TROUBLE SHOOTING	50

1 POLICIES

1.1 Important Note

Read and understand this manual prior to using this instrument. Carefully read the warranty policy, service policy, notices, disclaimers and revisions on the following pages.

This product must be installed by a qualified electrician or factory trained technician and according to instructions indicated in this manual. This instrument should be inspected and calibrated regularly by a qualified and trained technician. For more information, refer to Section 7 *Calibration* and Section 9 *Maintenance* of this manual.

This instrument has not been designed to be intrinsically safe. For your safety, **do not** use it in classified hazardous areas (explosion-rated environments).

INSTRUMENT SERIAL NUMBER:

PURCHASE DATE:

PURCHASED FROM:

1.2 Warranty Policy

Critical Environment Technologies Canada Inc. (CETCI), also referred to as the manufacturer, warrants this instrument, (excluding sensors, battery packs, batteries, pumps and filters) to be free from defects in materials and workmanship for a period of **two years from the date of purchase from our facility**. The sensors have a warranty period of **one year on a pro-rated basis from the date of purchase from our facility**. If the product should become defective within this warranty period, we will repair or replace it at our discretion.

The warranty status may be affected if the instrument has not been used and maintained per the instructions in this manual or has been abused, damaged, or modified in any way. This instrument is only to be used for purposes stated herein. The manufacturer is not liable for auxiliary interfaced equipment or consequential damage.

Due to ongoing research, development, and product testing, the manufacturer reserves the right to change specifications without notice. The information contained herein is based on data considered accurate. However, no warranty is expressed or implied regarding the accuracy of this data.

All goods must be shipped to the manufacturer by prepaid freight. All returned goods must be pre-authorized by obtaining a Returned Merchandise Authorization (RMA) number. Contact the manufacturer for a number and procedures required for product transport.

1.3 Service Policy

CETCI maintains an instrument service facility at the factory. Some CETCI distributors / agents may also have repair facilities; however, CETCI assumes no liability for service performed by anyone other than CETCI personnel.

Repairs are warranted for 90 days after date of shipment (sensors have individual warranties). Should your instrument require non-warranty repair, you may contact the distributor from whom it was purchased or you may contact CETCI directly.

Prior to shipping equipment to CETCI, contact our office for an RMA #. All returned goods must be accompanied with an RMA number.

If CETCI is to do the repair work, you may send the instrument, prepaid, to:

Attention: Service Department
Critical Environment Technologies Canada Inc.
Unit 145, 7391 Vantage Way
Delta, BC, V4G 1M3

Always include your Returned Merchandise Authorization (RMA) number, address, telephone number, contact name, shipping / billing information, and a description of the defect as you perceive it. Pack the equipment well (in its original packing if possible), as we cannot be held responsible for any damage incurred during shipping to our facility. You will be contacted with a cost estimate for expected repairs, prior to the performance of any service work.

For liability reasons, CETCI has a policy of performing all needed repairs to restore the instrument to full operating condition.

1.4 Copyrights and Registered Trademarks

This manual is subject to copyright protection; all rights are reserved. Under international and domestic copyright laws, this manual may not be copied or translated, in whole or in part, in any manner or format, without the written permission of CETCI.

Modbus® is a registered trademark of Gould Inc. Corporation.

1.5 Disclaimer

Under no circumstances will CETCI be liable for any claims, losses or damages resulting from or arising out of the repair or modification of this equipment by a party other than CETCI service

technicians, or by operation or use of the equipment other than in accordance with the printed instructions contained within this manual or if the equipment has been improperly maintained or subjected to neglect or accident. Any of the forgoing will void the warranty.

Under most local electrical codes, low voltage wires cannot be run within the same conduit as line voltage wires. It is CETCI policy that all wiring of our products meet this requirement.

It is CETCI policy that all wiring be within properly grounded (earth or safety) conduit.

1.6 Revisions

This manual was written and published by CETCI. The manufacturer makes no warranty or representation, expressed or implied including any warranty of merchantability or fitness for purpose, with respect to this manual.

All information contained in this manual is believed to be true and accurate at the time of printing. However, as part of its continuing efforts to improve its products and their documentation, the manufacturer reserves the right to make changes at any time without notice. In addition, due to improvements made to our products, there may be information in this manual that does not exist in the version of the product the user has. Should you detect any error or omission in this manual, or should you want to inquire regarding upgrading the device's firmware, please contact CETCI at the following address:

Critical Environment Technologies Canada Inc.

Unit 145, 7391 Vantage Way, Delta, BC, V4G 1M3, Canada

Toll Free: +1.877.940.8741

Telephone: +1.604.940.8741

Fax: +1.604.940.8745

Email: marketing@cetci.com

Website: www.critical-environment.com

In no event will CETCI, its officers or employees be liable for any direct, special, incidental or consequential damages resulting from any defect in any manual, even if advised of the possibility of such damages.

2 INTRODUCTION

2.1 General Description

Thank you for purchasing our LPT-P Digital Car Park Transmitter.

The LPT-P is an economical, digital transmitter with up to three gas channels, designed to be part of a gas detection system for enclosed parking garages / car parks and auto repair shop applications. Each LPT-P transmitter can be configured as:

- A single channel gas detector with an internal electrochemical Carbon Monoxide (CO) or Nitrogen Dioxide (NO₂) sensor
- A dual channel gas detector with an internal electrochemical Carbon Monoxide (CO) and Nitrogen Dioxide (NO₂) sensor
- A dual channel gas detector with an internal electrochemical Carbon Monoxide (CO) plus one catalytic ESH-A Remote Sensor
- A dual channel gas detector with an internal Nitrogen Dioxide (NO₂) sensor plus one catalytic ESH-A Remote Sensor
- A three channel gas detector with one internal CO sensor, one internal NO₂ sensor plus one catalytic ESH-A Remote Sensor

Features include a back lit, LCD digital display with user selectable function, standard Modbus® RTU RS-485 digital output and a standard water / dust tight, corrosion resistant enclosure that is IP54 rated with the factory installed splash guard. The LPT-P comes standard with Modbus® RTU wide

area network (WAN) output to Building Automation System (BAS) or Direct Digital Control (DDC) system.

All LPT-P digital transmitters operate by diffusion. The sensors utilized in this device are accurate enough to measure to Occupational Health & Safety (OHS) hazardous levels for toxic gases.

If after reading through the manual, you have any questions, please do not hesitate to contact our service department for technical support.

2.2 Key Features

- Up to 3 sensor configurations: single or dual internal CO or NO₂ sensor and/or one remote catalytic combustible gas sensor
- Modbus® RTU RS-485 serial communications
- Graphic LCD display (user selectable function)
- 4-conductor shielded network wiring (daisy-chain)
- 24 volt DC power
- Standard water / dust tight, corrosion resistant enclosure (drip proof). With optional splash guard installed, the enclosure is IP54 rated.
- RoHS compliant circuit boards
- Auto resetting fuses

3 INSTRUMENT SPECIFICATIONS

3.1 Technical Specifications

MECHANICAL

Enclosure	ABS / Polycarbonate, IP54 rated with splash guard installed. Copper coated interior to reduce RF interference.
-----------	---

Weight	400 g / 14 oz
--------	---------------

Size	127 mm x 127 mm x 71 mm / 5.0" x 5.0" x 2.8"
------	--

ELECTRICAL

Power Requirement	16 - 30 VDC, 3 W, Class 2 24V recommended. See Section 5.6 <i>Wiring Connections</i> .
-------------------	---

Wiring (4-wire)	24 VDC, 4-conductor shielded 16 awg stranded within conduit, network wiring (daisy-chain), Modbus® RTU (version 1.1b3) RS-485
-----------------	---

Fuses	Automatic resetting thermal
-------	-----------------------------

USER INTERFACE

Display	Graphic LCD, white border. Text prompting for calibration operation and fault indications. Installer configurable to suppress all other displays.
---------	---

Magnetic Switches	Use a magnetic wand to access menu options and program functions without opening the enclosure.
-------------------	--

INPUT / OUTPUT

Communication Modbus® RTU over RS-485	Modbus® ID: 100 (default, configurable)
	Baud rate: 19,200 (default, configurable)
	Data bits: 8
	Start bits: 1
	Stop bits: 1
	Parity: none
Analog signal	4-20 mA input signal from ESH-A Remote Sensor

ENVIRONMENTAL

Operating Temperature	-20°C to 40°C (-4°F to 104°F)
Operating Humidity	15 - 90% RH non-condensing

CERTIFICATION

Model: LPT-P-XXX
 S/N: LPTP1603B00001
 Rating: 16-30 VDC, 3W, Class 2

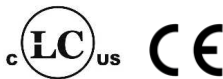

CERTIFIED FOR ELECTRIC SHOCK & ELECTRICAL FIRE HAZARD ONLY. LA CERTIFICATION ACNOR
 COUVRE UNIQUEMENT LES RISQUES DE CHOC ELECTRIQUE ET D'INCENDIE D'ORIGINE ELECTRIQUE.

Conforms to: CSA-C22.2 No. 205-12 / UL508 (Edition 17):2007
 Conforms to: EMC Directive 2004/108/EC, EN 50270:2006, Type 1, EN61010

Conforms to: FCC. This device complies with part 15 of the FCC Rules, Operation is subject to the following two conditions: (1) This device may not cause harmful interference, and (2) this device must accept any interference received, including interference that may cause undesired operation.

3.2 Internal Sensor Gas Types

Internal Electrochemical Sensors	Part Number	Range	Lifespan
Carbon Monoxide (CO)	LPT-P-TCO	0 - 200 ppm	6 years
Nitrogen Dioxide (NO ₂)	LPT-P-NO2B	0 - 10 ppm	6 years

3.3 ESH-A Remote Sensor Gas Types

ESH-A Remote Sensors Combustible (Catalytic)	Part Number	Range	Lifespan
Hydrogen (H ₂)	ESH-A-CH2-100	0 - 100% LEL	5 years
Methane (CH ₄)	ESH-A-CCH4-100	0 - 100% LEL	5 years
Propane (C ₃ H ₈)	ESH-A-CC3H8-100	0 - 100% LEL	5 years

3.4 Enclosure Dimensions

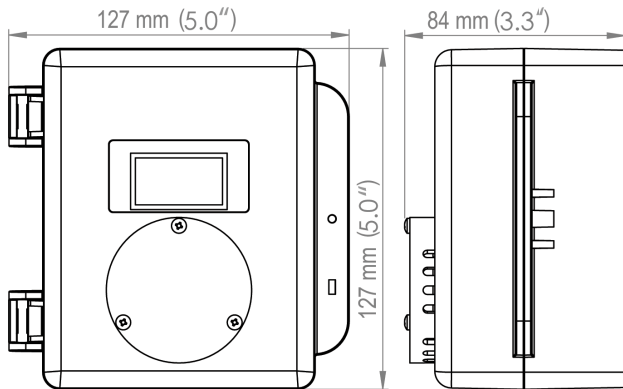

Above dimensions are shown with optional splash guard. Without splash guard, thickness is 71 mm (2.8"). The area required for enclosure door to be open 90 degrees is 178 mm (7.0") or 254 mm (10.0") for fully open. With the optional splash guard installed, the enclosure is IP54 rated.

NOTE: During calibration the sensor response time will be slower with a splash guard installed.

4 INSTRUMENT FEATURES

4.1 Exterior Enclosure

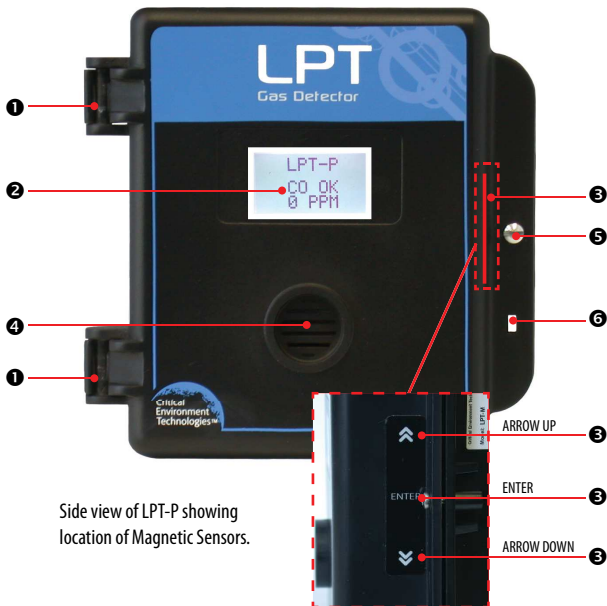

NUMBER	FEATURE	FUNCTION
1	Door Hinge	Secures door to base and allows easy opening and closing
2	Display with white border	Graphic LCD display.
3	Magnetic Switches (arrow up, Enter, arrow down)	Use a magnetic wand to access menu options and program functions without opening the enclosure
4	Sensor Opening	Allows gas diffusion into sensor
5	Door Screw	Secures door shut
6	Padlock Opening	For security padlock

4.2 Interior System Layout

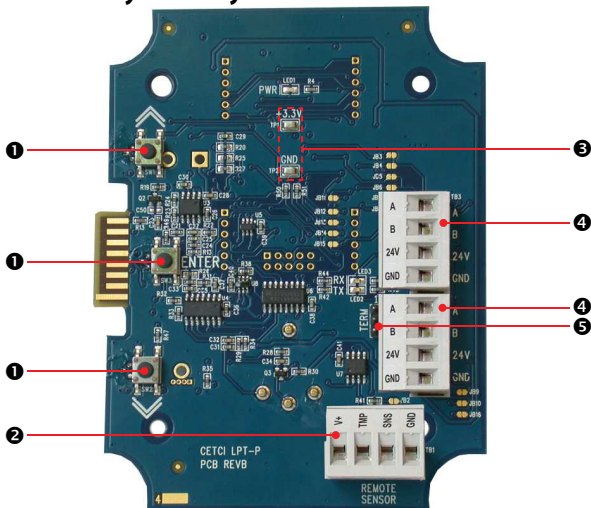

NUMBER	FEATURE	FUNCTION
①	Programming Buttons	Access menu options and program functions using buttons inside the enclosure. (Arrow up, Enter, Arrow down)
②	Remote Sensor Terminal	Terminal for connecting the ESH-A Remote Sensor

③	TP1 and TP2	Test Points 1 and 2 to confirm voltage registers are working. Reading should be 3.3 volts.
④	RS-485 Communication Terminals	Pluggable power and signal terminal for connection to controller and next transmitter.
⑤	Termination Resistor	Network termination resistor. "IN" position includes 120 ohm resistor.

5 INSTALLATION

The sensor in the LPT-P goes through a burn in period at our factory prior to shipping so it is ready for operation upon arrival. If you install the LPT-P when it arrives the sensors will require about a 5 minute warm up period. If the device is not installed within two weeks of delivery, the sensors may require a longer warm up time to stabilize (approximately 48 hours) and provide accurate readings.

NOTE: CETCI suggests that upon power-up, all sensors be left to warm up for 24 hours prior to considering the gas readings to be accurate.

NOTE: All sensors are calibrated in the factory and do not require calibration at the time of a routine installation.

NOTE: A bump test will help you determine if a sensor requires calibration. If the sensor still does not respond as it should after a successful calibration, it probably requires replacing.

NOTE: Silicone, lead and chlorinated hydrocarbon vapours can poison catalytic sensors.

NOTE: Temperature affects calibration. It is important to ensure the gas is at the appropriate temperature during calibration. If the sensor is being used in an extreme temperature range,

calibration should be done in that same temperature range.

5.1 General Safety Warnings

The LPT-P is intended for indoor use, permanently mounted at a height that is appropriate for the type of gas being monitored. See Section *5.4 Mounting the Transmitter*. The LPT-P should be protected from extreme weather conditions.

The LPT-P requires no assembly and virtually no maintenance other than regular calibration of the integral and/or remote sensors and ensuring that excess water or dust is not somehow entering the enclosure and physically damaging the circuit board or internal components. There are no serviceable elements other than the calibration instructions outlined in this manual. There are no replaceable components except the sensors.

5.2 Protection Against Electrical Risks

Disconnect all power before servicing. There may be multiple power sources. Power supply may have a building installed circuit breaker / switch that is suitably located and easy to access when servicing is required and should be labelled as LPT-P supply (disconnecting power to the LPT-P).

Appropriate markings should be visible at the circuit breaker / switch that is supplying power to the LPT-P.

This device may interfere with pacemakers. Modern pacemakers have built-in features to protect them from most types of interference produced by other electrical devices you might encounter in your daily routine. If you have a pacemaker, follow your healthcare provider's instructions about being around this type of equipment.

5.3 Protection Against Mechanical Risks

The door of the enclosure can be removed if absolutely necessary to facilitate installation of the base but it is not recommended on this version. Extreme care and caution must be exercised when removing the door to avoid damaging the hinges. The door should only be removed when absolutely required. Any damage occurring from door removal procedure will not be covered under warranty.

Simply grasp the door with one hand, being careful not to make contact with any of the internal components (circuit board), grasp the base with your other hand. Tug on the base and pull straight apart. **DO NOT TWIST**. The section of the hinges located on the base should “snap” apart from the part of the hinges located on the door.

After installation, simply locate the lid hinges over the installed base hinges and pull toward you. The hinges should easily “snap” back into place.

The enclosure has one screw securing the door to the base for electrical safety and provides an opening to allow the user to apply a padlock or tie wrap if they desire the transmitter to be locked. See Section 4.1 *Exterior Enclosure*.

Be aware that the hinged door that could potentially pinch fingers and the sharp edges and/or jumper pins on the board could potentially prick or cut fingers if not handled carefully.

5.4 Mounting the Transmitter

The LPT-P should be mounted on a flat vertical surface using the four 4.4 mm / 0.175 in diameter mounting holes provided to maintain water tight status. Care should be taken to ensure that the face of the LPT-P is not obstructed in order to maximize the sensor’s exposure to the environment being monitored.

Two 12.7 mm / ½ in conduit entry points are provided in the enclosure. Both are located in the enclosure base. One in the rear of the base and one on the bottom edge of the base. See Section 5.5 *Enclosure Mounting Components*.

The clearance from the PCA to the base enclosure is 12.7 mm / ½ in. **Do not use a conduit connector that has more than 12.7 mm (½ in) of thread length.**

NOTE: When mounting the enclosure, allow enough room to allow the end user to open the door fully to access the internal adjustments.

5.4.1 Wet Environment Considerations

If the LPT-P is to be installed in a potential hose-down application or any application whereby liquid could be directed towards the sensor opening, the LPT-P should be ordered with an optional attached splash guard (factory installed).

If used in a wet or wash down application, the conduit hub entering the LPT-P enclosure must be liquid tight type.

Any water or physical damage to the transmitter that occurs from the installer drilling their own installation holes will not be covered under warranty.

5.4.2 EMI and RF Interference Considerations

All electronic devices are susceptible to EMI (Electromagnetic Interference) and RFI (Radio Frequency Interference). Our detectors have been designed to reduce the effects of these interferences and we meet CSA FCC and CE requirements for these type of devices. However, there are still circumstances and levels of interference that may cause our equipment to respond to these interferences and cause them to react as if there has been gas detected.

There are some installation procedures that will reduce the likelihood of getting faulty readings:

1. Locate the detectors and controllers out of the way from normal foot traffic and high energy equipment.
2. Confirm the devices are properly grounded using conduit and shielded cabling.
3. Inform operators and technical staff working in the surrounding area to be aware of these possible conditions and that two way radios, Bluetooth enabled devices, cell phones and other electrical equipment may interfere with the response of the gas detectors.

5.4.3 Mounting Height (Sensor Dependent)

The sensor mounting height depends on the density of the gas relative to air. Heavier than air gases should be detected 6 in / 15 cm from the floor, lighter than air gas sensors should be placed on or near the ceiling, and gases which have a density close to that of air should have sensors installed in the “breathing zone” 4 - 6 f / 1.2 - 1.8 m from the floor. The breathing zone refers to the area 4 - 6 ft / 1.2 - 1.8 m from the floor, where most human breathing takes place. This is a good default location for sensors, as many gases are often well dispersed in air.

GAS	APPLICATIONS / TYPES	SUGGESTED MOUNTING HEIGHT
Carbon Monoxide (CO)	Gas engine exhaust	1.2 - 1.8 m (4 - 6 ft)
Nitrogen Dioxide (NO ₂)	Diesel engine exhaust	above the floor
Hydrogen (H ₂)	Electric car charging stations or battery charging rooms	Near the ceiling
Methane (CH ₄)	Buildings built on landfill sites	Near the ceiling
Propane (C ₃ H ₈)	Propane fuel	15.24 cm (6 in) above the floor

5.5 Enclosure Mounting Components

5.5.1 Enclosure Base

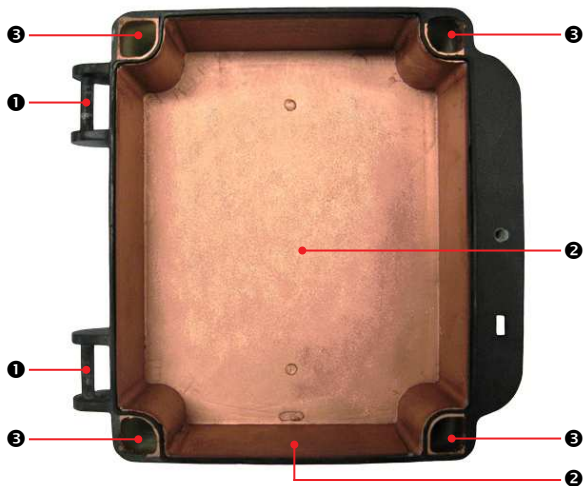

NUMBER	FEATURE
1	Door Hinge
2	1/2" Conduit Entry Knockout
3	Mounting Holes

5.5.2 Enclosure Bottom



NUMBER	FEATURE
1	Door Hinge
2	1/2" Conduit Entry Knockout

5.6 Wiring Connections

The LPT-P digital transmitter is a low voltage powered device. Any application of operating voltages higher than indicated in the specification may result in damage. Double check wiring connections prior to powering the transmitter. Damage from incorrect wiring connections or from too much voltage applied is not covered under warranty.

All wiring should be run in EMT (or better) conduit properly earth grounded. All communications (network) wiring must be in shielded cabling. The shield should be connected to earth ground close to the primary supply connection only, and must have a contiguous connection throughout the network. Communication uses a daisy chain configuration. The recommended 4 conductor, 16 AWG, shielded stranded wire cable types are AlphaWire 79220, Belden 9954 or equivalent.

NOTE: WARRANTY VOID IF SOLID-CORE WIRE IS USED AT THE WIRING TERMINAL STRIP.

When using solid core wiring for distribution (in the conduit), use stranded wire pigtails 18 AWG within the enclosure to connect to the circuit board. The rigidity of solid-core wire can pull a soldered terminal strip completely off a circuit board and this will not be covered under warranty.

5.6.1 Power & Output Connections

If the LPT-P is being connected to either a QCC or FCS the supply voltage will either be supplied by the QCC or FCS and any additional power requirements of the system will be supplied by RPS-24VDC Remote Power Supply devices. If the LPT-P is being used on systems other than a QCC or FCS then either 24 VDC power supplies or 24 VAC Class 2 Transformers need to be used. In all cases the voltage supply to the LPT-P should never drop below 18 VDC or 20 VAC.

System power: The main wiring terminal strip on the LPT-P circuit board can be unplugged for easier wiring installation. Grasp the two sides of the terminal strip and pull sideways.

Device must be used with rated equipment. External power to LPT-P must be supplied by a Class 2 or better transformer.

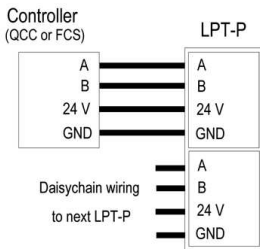
Wiring Example: 4-Wire 24 VDC

5.6.2 ESH-A Remote Sensor Wiring Connection

Each ESH-A is given the same serial number as the device it is being connected to. Make sure to connect the ESH-A to the LPT-P that has the same serial number or the system won't work.

Four-conductor, 16-18 awg stranded shielded cable is required for the ESH-A Remote Sensor wiring. This wiring should be run in a conduit, separate from the signal output, and should not exceed 61 m (200 ft). The voltage at the remote sensor (Red V+ to Black GND) should be 24 VDC. If this voltage is not met after installation, the wrong gauge wire may have been used or the wiring run is too long.

Wiring Example: ESH-A Remote Sensor

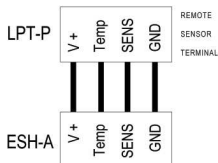

The maximum length of wire between the ESH-A Remote Sensor and the LPT-P transmitter should not exceed 200 ft (61 m).

5.6.3 Wire Gauge vs Run Length

The table below shows the maximum cable length between the LPT-P and a controller for normal installations.

SUPPLY VOLTAGE	RS-485 BUS IMPEDENCE	WIRE GAUGE (AWG)	MAXIMUM CABLE LENGTH (feet)
22 VDC minimum	on board termination resistor available (J4)	low capacitance shielded wiring, 18 AWG	2000 at 19,200bps

In large system applications, if the recommended maximum cable length needs to be exceeded, an LNK-XT Network Extender can be used to boost the waning signal strength. One LNK-XT extends the network length by an additional 610 m (2000 ft). It is recommended that an LNK-XT be installed approximately every 32 LPT-P devices, or when a drop in voltage is detected.



6 SYSTEM OPERATION & CONFIGURATION

NOTE: The LPT-P is **not** a standalone gas detection device as it does not have an internal buzzer or on board relay. The LPT-P must be connected to a controller, a control panel, Direct Digital Control system (DDC) or Building Automation System (BAS).

The LPT-P continuously monitors gas concentrations on the configured channels and communicates the information back on request to a Controller or BAS / DDC via Modbus® RTU RS-485. Based on the gas concentration readings, the Controller or BAS / DDC will trigger the safety responses (alarms, relays, etc.) as it has been programmed.

6.1 Navigating the Menu Structure

There are three programming push-buttons inside the enclosure that can be used to navigate through the LPT-P menu structure, or you can use the magnetic wand without needing to open the enclosure (refer to *Section 4.1 Exterior Enclosure* for location of the magnetic switches. The three magnetic switches are indicated by an ARROW UP, ENTER and ARROW DOWN along the side of the enclosure. The magnetic switches function the same as pressing the buttons inside the enclosure.

	ARROW UP - used for going up through the menus or incrementing values or selecting an alpha character
	ENTER - used primarily as an enter key, either for getting to the next screen or stepping through a numeric or alpha value
	ARROW DOWN - used for scrolling down through the menus or decrementing values or selecting an alpha character

NOTE: The directions in this manual are given using the magnetic wand to engage the magnetic switches on the side of the enclosure. However the same instructions can be followed when using the programming buttons inside the enclosure. Refer to Section 4.2 *Interior System Layout* for the location of the programming buttons.

After entering the menus, pressing the ARROW UP key will normally take you to the Exit screen. Most menus are circular and will bring you back to the Exit screen.

6.2 Accessing the Menu with Passcodes

The main menu structure is broken down by the passcode access entry. These passcodes allow for direct access to the parts of the menu system of interest.

CODE	NAME	DESCRIPTION
1001	Hardware Configuration	<ul style="list-style-type: none">Adjust Display ContrastChange Modbus IDChange Baud Rate

3032

Sensor
Configuration

- Enable/Disable Channels
- Calibrate Zero
- Calibrate Span
- Set Span Gas Value
- Set Channel Alarm Setpoints and Hysteresis (Setpoint Differential)
- Test Gas Reading Response
- Temp Local (used for factory troubleshooting only)

6.3 Power Up and Warm-up

The current gas level reading can be monitored at any time during normal operation using the display. The display will be backlit when the menu is in active use.

Upon application of power, the device will enter the warm-up period and display a countdown of the time remaining before it is done warming up.

NOTE: The LPT-P will be visible on the BAS / DDC system during the warm-up countdown but a correct reading will not show up until the unit has finished the warm-up period and the sensor(s) has stabilized.



After the warm up period (3 minutes), the device may exhibit gas alarm conditions if the sensor has not completely stabilized during the warm up period. This is normal and the length of time the gas

alarm exists is dependent upon the length of time since the unit was last powered up and the state of the environment it is installed in.

6.4 Display Select

After warm up and upon normal operation, the display will cycle through and show a summary of the status of the gas readings for each enabled channel / sensor. This is the factory default position.



Each gas channel splash screen will show the current status of the channel:

- OK - gas channel is operating normally
- LOW - gas channel is in low alarm
- MID - gas channel is in mid alarm
- HIGH - gas channel is in high alarm
- FAULT - gas channel is in fault
- COMM - controller has been unable to communicate with the LPT-P for at least 300 seconds; in addition, the backlight will illuminate making it easier to find the gas detector from far away

Using the magnetic wand (or buttons inside the enclosure) you can scroll through the other splash screens that show the devices' serial number, Modbus® ID setting and current sensor temperature reading.

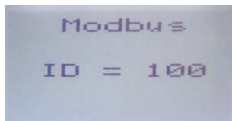

6.5 Set LCD Display Contrast Level

The contrast level of the LCD display can be changed to be made more visible in high light, low light and/or different temperatures that may require a different contrast setting.

In the Hardware Configuration Menu (passcode 1001), press either ARROW to scroll through the menu and select Contrast Adjust. Press ENTER to select. Use the ARROW keys to enter a number between 00 and 35. The factory default contrast level is 20.

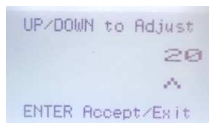
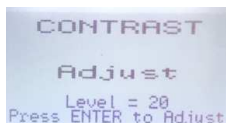

6.6 Fault Detection

The LPT-P has built in fault detection, and in the event of a problem with the measurement circuitry the transmitter will indicate a fault condition on the display. Normal operation will resume once the fault condition has been corrected.

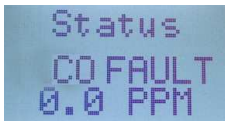

NOTE: While faults in the circuitry can be detected, a dead or damaged electrochemical sensor will usually appear to the transmitter as a zero gas reading. To ensure safe operation, periodic bump tests are required.

6.7 Modbus® Settings

The LPT-P transmitter operates on a local area network (LAN) using Modbus® RTU RS-485 serial communications. Complete systems (controller with digital transmitters and peripherals) will be shipped pre-configured with the appropriate Modbus® ID and baud rate.

In order for communication to be successful between devices, be sure your network connection is complete, the network termination switches are set appropriately and all the devices are configured with the same baud rate, character format, etc. Each device will have its own unique Modbus® ID.

Individual transmitters being added to an existing system may require changes to the default Modbus® settings.

6.7.1 Change Modbus® ID

If required, you can change the Modbus® ID assigned to an LPT-P transmitter. In the Hardware Configuration Menu (passcode 1001), press either ARROW to scroll through the menu and select Modbus®.

Press ENTER and use the ARROW keys to change the ID number. Move to the next digit by pressing ENTER. When finished, press ENTER to save and Exit.

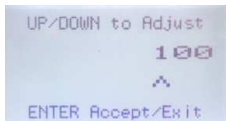
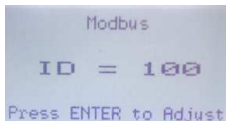

6.7.2 Change Baud Rate

All devices on the same network must have the same baud rate. The default Modbus® baud rate for all CETCI Modbus® devices is 19,200. If you need to change the baud rate, in the Hardware Configuration Menu (passcode 1001), press either ARROW to scroll through the menu and select BAUD.



Press ENTER and use the ARROW keys to scroll through the baud rates to choose from:

- 9,600
- 14,400
- 19,200 (default, configurable)
- 38,400
- 57,600
- 76,800
- 115,200

Select the preferred baud rate by pressing ENTER to save and Exit.

6.7.3 Modbus® Holding Registers

If you have specific requirements, have any questions or require clarification about the Modbus® holding registers, please contact CETCI for assistance.

6.8 Setting Channel Alarm Setpoints

The LPT-P is configurable as a one, two or three channel gas detector and each channel has three gas alarm setpoints, LOW, MID and HIGH which can be ascending or descending. The number entered as the setpoint is the exact number at which the gas concentration reading will be determined as being LOW, MID or HIGH. The information will be read by the Controller or BAS and the appropriate safety measures, such as triggering a relay(s), sounding an alarm, etc. will occur as programmed into the Controller or BAS.

Almost all installations will use the factory default alarm setpoints. The default setpoints are:

SENSOR GAS TYPE	LOW ALARM	MID ALARM	HIGH ALARM
Carbon Monoxide (CO)	25 ppm	50 ppm	100 ppm
Nitrogen Dioxide (NO ₂)	0.7 ppm	1.0 ppm	1.5 ppm
Combustibles (catalytic)	10% LEL	15% LEL	20% LEL

NOTE: If Channel 1 is not being set, follow the same steps using Channel 2 and/or Channel 3.

6.8.1 Setting the Low Alarm Setpoint

In the Sensor Configuration Menu (passcode 3032), press either ARROW key to scroll through the menu and select the channel for which you are setting the alarm setpoint.

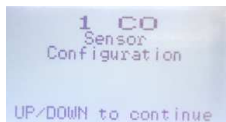
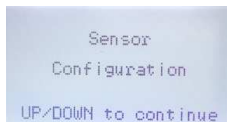

Press ENTER and use the ARROW keys to scroll through the menu and choose SP Low. Press ENTER and use the ARROW key to choose ASCENDING or DESCENDING.

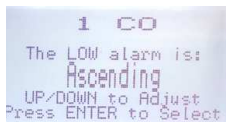
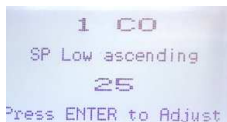

Press ENTER again to change the setpoint value by using the ARROW keys to increase or decrease the number. Press ENTER to move to the next digit and again to save and Exit the screen.

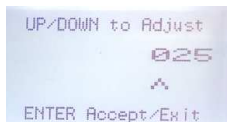

NOTE: An **Ascending alarm** is used when the normal gas level starts out below the alarm setting and when the reading goes above it, the alarm will trip. A **Descending alarm** is used when the normal gas level starts above the alarm setting and when the reading goes below it, the alarm will trip. The descending alarm is commonly used with Oxygen sensors.

6.8.2 Setting the Mid Alarm Setpoint

Follow the same procedure as the *7.8.1 Low Alarm Setpoint*, choosing the SP Mid menu option.

6.8.3 Setting the High Alarm Setpoint

Follow the same procedure as the 7.8.1 *Low Alarm Setpoint*, choosing the SP High menu option.

6.8.4 Setting Hysteresis

Hysteresis is the difference between the ON point and OFF point of the alarm. You can set a hysteresis value that will be common for all alarm setpoints on that channel. For example, if the alarm is set to come on at 100 ppm and the hysteresis is set for 5 ppm, the alarm will not turn off until the gas is below 95 ppm. This prevents the alarm from chattering on and off repetitively if the gas fluctuates just above and just below 100 ppm.

In the Sensor Configuration Menu (passcode 3032), press either ARROW key to scroll through the menu and select the channel for which you are setting the hysteresis value. Scroll through the menu options to SP Diff and press ENTER to select.

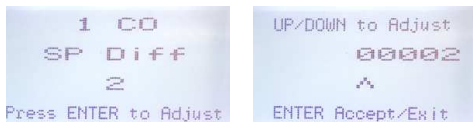

Use the ARROW keys to increase or decrease the number. Press ENTER to move to the next digit and again to save and Exit the screen.

6.9 Enable / Disable Channels

This setting allows you to enable or disable the channel(s). If a channel with a viable sensor is disabled, the gas readings gathered by that channel will not be used to control the relays and/or alarms.

In the Sensor Configuration Menu (passcode 3032), press either ARROW key to scroll through the menu and select the channel you want to disable.



Press ENTER and use the ARROW key to scroll to the Enable screen. Use the ENTER key to choose ON or OFF. Use the ARROW key to move on to the next menu item and ENTER to Exit.

6.10 Test Gas Reading Response / Send Test Reading to Controller

NOTE: Before conducting this test, notify the appropriate people so unnecessary distress or response is not caused.

NOTE: This functionality is available in firmware version 1.29 onwards.

This test allows you to send a forced gas reading to the controller without having to expose the sensor to actual gas, so you can make sure the LPT-P is connected to the controller properly after installation and is still initiating an appropriate response from the controller during routine maintenance checks. The test only applies to the channel you have chosen.

In the Sensor Configuration Menu (passcode 3032) press either ARROW key to scroll through the menu and select the channel for which you want to test the gas reading response.

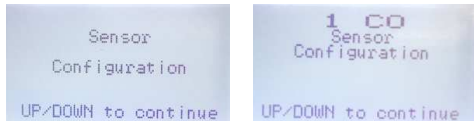

Press ENTER and use the ARROW keys to scroll through the menu and choose TEST. Press ENTER and use the ARROW key to increase or decrease the value and the ENTER key to move to the next digit.

NOTE: You will only be able to enter a value that falls within the factory configured range of the sensor. If you try to enter a number outside that limit, the value will return to a valid value.

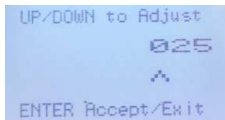
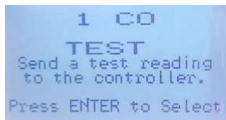

When finished, press ENTER to accept and Exit the screen. The gas level reading for that channel will be immediately sent to the controller. This test reading will override any actual gas reading for that channel for the duration of the test.

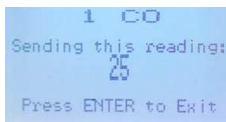

To stop the test, press ENTER to Exit. If you do not exit the test, the test will timeout after 5 minutes and return to normal operation. Repeat for each channel you want to test.

7 CALIBRATION

7.1 Calibration Specifications

7.1.1 Gas

Calibration span gases should have at least $\pm 5\%$ accuracy and have a current date stamp. Gas generators should have a current dated cell installed. Service personnel should flow zero emissions air or 20.9% volume O_2 (scrubbed of hydrocarbons) before attempting to null adjust toxic gas sensors. In some cases nitrogen (N_2) can be substituted for zero air when null adjusting electrochemical sensors. Contact CETCI for clarification.

Every LPT-P transmitter is calibrated in a chamber by true diffusion method prior to leaving our facility. This method more closely emulates actual “real world” conditions. Field calibration using gas cylinder, regulator and hose directing span gas into the sensor may result in slightly higher readings. It is important to note that the type of gas mixture, how old the gas is and what temperature it has been stored at will also affect repeatability during field calibration.

NOTE: Catalytic sensors require oxygen to work and thus the user **MUST** flow clean air or Oxygen to obtain a true zero and the span gas must have “air” balance, not N_2 balance.

7.1.2 Regulators & Flow

Calibration gases that are lighter than or the same weight as air (CO , O_2 , etc.) should be flowed at 0.5 LPM. Gases heavier than air (NO_2 , etc.) should be flowed between 0.5 and 1.0 LPM. Fixed flow regulators provide more accuracy.

7.1.3 Adapters

The proper calibration adapter should be utilized to allow the gas to properly diffuse around the sensor. The calibration adapter plug for an LPT-B with an internal sensor without a splash guard is part number **CET-7000-CAP**. For an LPT-B with a splash guard, you will need to use the Cal Clip, part number **CET-SGC**.

7.1.4 Calibration Frequency

- Parking garage detectors: Once every 12 months
- OHS applications: Once every 6 months (OHS: Occupational Health & Safety)
- For best performance and to meet published specifications: once every six months

NOTE: A calibration label should be applied after every calibration to confirm work performed and the date it was confirmed. If a controller is involved, the alarm set points should be indicated on a label on the front door of the enclosure so anyone working in the environment can be aware.

Equipment: Calibration Kit, Calibration gases, Digital multi-meter, magnetic wand

Users can order the Calibration Kit, calibration accessories and / or gases (shipping restrictions may apply) from any CETCI authorized distributor or they can supply their own gas and equipment as long as the gas meets the minimum specifications. CETCI does not ship gases outside of Canada.

7.1.5 Gas Testing Frequency (Bump Testing)

For the purpose of safety in OHS applications, sensors should be gas tested (bump tested) once every month to confirm response and alarm activation.

7.1.6 Non-Intrusive Calibration

Calibration can normally performed without opening the unit by using a magnetic wand to engage the magnetic switches that are on the side of the enclosure. Refer to Section 4.1 *Exterior Enclosure* for location photo. This is particularly useful if in a wet or dirty environment. A magnet of sufficient strength will be required to trip the sensors. Such a magnet is included in the Calibration Kit (see Section 8.4 *Calibration Kit* and can also be ordered separately from CETCI under part number **CET-MW**).

To initiate non-intrusive calibration, touch the magnet to one of the marks on the side of the enclosure and follow the screen prompts along with the instructions in this section.

NOTE: The programming buttons inside the enclosure can be used instead of the magnetic wand, if preferred.

7.2 Calibrating the Internal CO and/or NO₂ Sensor(s)

NOTE: If an inappropriate concentration of span gas is applied during calibration, calibration may succeed but it does not mean the equipment has been calibrated properly. CETCI is not responsible for improperly calibrated transmitters. Follow manual instructions carefully.

The steps below show how to calibrate a CO sensor. Follow the same step for calibrating an NO₂ sensor, choosing the menu options for the channel assigned to NO₂.

To calibrate the internal sensor(s), the user must go through the following steps:

Step 1

In the Sensor Configuration Menu (passcode 3032), press either ARROW key to scroll through the menu and select the channel you want calibrate. Press ENTER and use the ARROW key to scroll to Calibrate Zero. Press ENTER and use the ARROW keys to enter a value of 0.

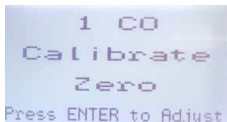

Attach the regulator to the cylinder of zero air, insert calibration adapter into the sensor opening on the front of the enclosure door (see Section 7.3.1 *Calibration Adapter Plug* if the adapter will not fit). Press Enter to start the Zero calibration. The display will show a countdown from 18 seconds.

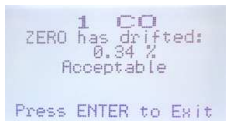

When the process has finished and the Zero calibration was accepted, press ENTER to Exit and remove the cylinder of zero gas. Refer to Section 7.3.3 *Zero - Requires Override* if the Zero calibration was not successful.

NOTE: After 5 minutes of inactivity, the display will return to the normal operation.

Step 2

Set the span calibration gas level. It is important to make sure that the span gas level value matches the calibration gas concentration you are using to calibrate the sensor.

The factory default calibration gas concentrations are:

SENSOR GAS TYPE	CALIBRATION GAS LEVEL
Carbon Monoxide (CO)	100 ppm
Nitrogen Dioxide (NO ₂)	5 ppm
Combustibles	20% LEL

In the Sensor Configuration Menu (passcode 3032), press either ARROW key to scroll through the menu and select the channel you want calibrate. Press ENTER and use the ARROW key to scroll to Calibrate Span. Press ENTER and use the ARROW keys in increase or decrease the span gas value.

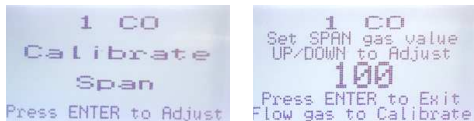

When the correct value is displayed, attach the regulator to the span gas cylinder and flow the span gas over the sensor. Once gas is detected, display will show a countdown from 180 seconds (3 minutes).

NOTE: If an inappropriate concentration of span gas is applied during calibration, calibration may succeed but it does not mean the equipment has been calibrated properly. CETCI is not responsible for improperly calibrated transmitters. Follow manual instructions carefully.

When the process has finished and the Span calibration was accepted, remove the cylinder of span gas. Refer to Section 7.3.4 *Span - Requires Override* if the Span calibration was not successful.

Repeat the calibration steps above for each enabled gas channel.

NOTE: After 5 minutes of inactivity, the display will return to the normal operation.

NOTE: If required, the Zero Calibration and the Span Calibration procedures can be done independently of each other. Refer to Section 7.3.2 *Zero Calibration Shift* for more information.

7.3 Trouble Shooting Calibration

This section is intended to aid in correcting issues that may arise during the calibration procedure. If you are unable to correct a problem or you have questions, please contact our service department at service@cetci.com or 604-940-8741 (Local) or 1877-940-8741 (Toll Free).

7.3.1 Calibration Adapter Plug

Use a slight twisting motion as you gently push the calibration adapter into the sensor opening. If the calibration adapter is hard to insert, moisten the O-ring seal slightly then try re-inserting it. If the splash guard is installed, use calibration adapter p/n: **CET-8000-GRS**.

NOTE: Response time will be slower with the splash guard installed.

7.3.2 Zero Calibration Shift

If all that is desired is to do a zero calibration shift, complete Step 1 in Section 7.2 *Calibrating the Internal Sensor(s)*. A zero shift calibration is only done when the LPT-P is being installed for the first time. The reason for a zero shift calibration is to compensate for the new environment in which the LPT-P is being installed.

7.3.3 Zero - Requires Override

If the gas level (possible residual gas) is too high, but still within the override range, the display will indicate that an override is required.

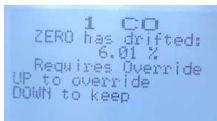

To override the value use the UP ARROW to select the desired value. To keep the original zero value, use the DOWN ARROW. Press ENTER to Exit.

7.3.4 Span - Requires Override

During the Span calibration, readings are taken and from the results sensitivity is calculated and compared to the original sensitivity of the sensor at the time of installation. If this sensitivity is below the override range, but above the fault limit, the display will indicate that an override is

required. To override the value use the UP ARROW to select the desired value. To keep the original value, use the DOWN ARROW. Press ENTER to Exit.

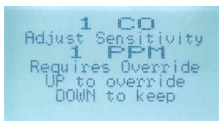

7.3.5 Fault Reading

If the LPT-P is giving a fault reading then either the LPT-P has failed a previous calibration and cannot calculate the expected voltage, or there has been a fault that the LPT-P cannot correct for. In either case all that can be done is to attempt a complete calibration from the beginning (Step 1) and determine if this corrects the fault. If a calibration does not resolve the fault then the LPT-P may need a new sensor. If that does not correct the fault, please contact our service department at service@cetci.com.

7.3.6 Calibration Failure

If the calibration fails while calibrating one of the sensors, you can try to calibrate it again, but more than likely the sensor needs replacing. Over time, a sensor has degrades and when it has gone beyond an acceptable level, it has reached its end of life and will no longer pass a calibration.

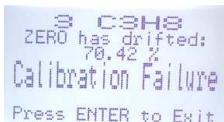

7.4 Calibrating an ESH-A Remote Sensor Connected to an LPT-P

There are two different processes for calibrating an ESH-A Remote Sensor. One process is for a new or replacement sensor and the other is for a properly functioning sensor. For either process, first ensure that the sensor has been continually powered for at least 24 hours.

7.4.1 Zero and Span Calibration of a Responsive ESH-A Remote Sensor (done at the LPT-P)

If the sensor does not need to be replaced and is responding correctly, the Zero and Span calibrations will need to be done at LPT-P transmitter that the ESH-A is connected to.

Make sure both the LPT-P and the ESH-A Remote Sensor are powered up and have warmed up for a 24 hour period prior to calibration. On the LPT-P, in the Sensor Configuration Menu (passcode 3032), press either ARROW key to scroll through the menu and select the channel assigned to the ESH-A. Follow the instructions in Section 7.2 *Calibrating the Internal Sensor(s)* **with the exception of applying the gas to the ESH-A sensor opening instead of the LPT-P sensor opening.**

7.4.2 Zero Calibration of a New or Replacement ESH-A Remote Sensor

If a new replacement sensor has been installed, the ESH-A will require a zero calibration of its sensor. This process will normally be required if the sensor has been replaced or there is concern that the sensor is not responding correctly.

Make sure the ESH-A Remote Sensor is powered up and has been warmed up for a 48 hour period prior to calibration.

Step 1

Open the ESH-A Remote Sensor enclosure. Move the jumpers from their resting position to JP1-1 and JP1-2 (bottom two jumper positions).

Step 2

Apply the correct Null gas for the type of sensor installed, for a minimum of 2 minutes.

Step 3

Attach a volt meter to TP1 and TP2. Using the POT RN1 potentiometer (located on the left underside of the ESH-A board), adjust the voltage to read 0.40 VDC. Verify that the voltage output from digital multi-meter leads attached to test points TP1 and TP2 on the LPT-P is reading 0.0 VDC. (a Zero and Span Calibration of the LPT-P will be required if this is not the case).

Step 4

Return the jumpers to their original positions and close the ESH-A.

Step 5

On the LPT-P, in the Sensor Configuration Menu (passcode 3032), press either ARROW key to scroll through the menu and select the channel assigned to the ESH-A. Follow the instructions in Section 7.2 *Calibrating the Internal Sensor(s)* **with the exception of applying the gas to the ESH-A sensor opening instead of the LPT-P sensor opening.**

8 ACCESSORIES

8.1 Splash Guard (Option: -S)

The splash guard attaches to the front of the enclosure to protect the sensor during water spray or washdown applications. It is factory installed and when attached the enclosure meets IP54 standards.

NOTE: The splash guard will slow down the response time of the sensor.



8.2 Magnetic Wand (p/n: CET-MW)

The magnetic wand is used for accessing menu options and program functions without opening the enclosure. Use to engage the magnetic switches on the side of the LPT-P.



Lifts	226.7 g (½ lb) solid steel
Size	66.6 mm x 6.35 mm (2 5/8" X 1/4") Hexagon

8.3 Metal Protective Guard (p/n: SCS-8000-RSG)

The metal protective guard is made of heavy duty metal and helps to protect against abrasive damage, theft and vandalism to the transmitters. It is made from 16-gauge galvanized steel and has 13 mm (½") square openings in the front to allow gas and air to flow through to the sensor. With only four slotted mounting holes, the installation and removal for equipment servicing is easy.



Enclosure	16 gauge galvanized steel
Weight	800 g (28 oz)
Size	178 mm W x 160 mm H x 91 mm D (7.0" W x 6.3" H x 3.6" D)

8.4 Calibration Kit (p/n: CET-715A-CK1)

The Calibration Kit contains the items necessary for common field and shop calibrations. It comes in a durable, hard plastic carrying case and includes a regulator, adapters, humidification chamber, brass fitting, hand tools and tubing. It does not include cylinders of gas. These must be ordered separately.



Calibration Kits and gases are available from the CETCI factory. Many gases, but not all are carried in inventory. Check with any CETCI authorized distributor for availability of specific gas types. **Gas cylinders cannot be shipped from Canada to other countries, including the USA.** For more

9 MAINTENANCE

The LPT-P transmitter requires virtually no maintenance other than regular calibration of the sensor.

The transmitter should be monitored for possible damaging conditions.

- The sensor port should be kept free of dirt or soot build up.
- If in a damp location, source of water should be shielded from contacting the top of the transmitter.
- If located in a working area, the front of the transmitter should be kept clear.
- If painting is to be conducted in the transmitter's location the transmitter needs to be protected from over spray and the sensor port should not receive paint fumes – these fumes may damage or reduce the life of the sensor.

11 TROUBLE SHOOTING

LPT-P won't power up. (blank display)

Is the power properly connected? Check the connections. Refer to Section 5.6 *Wiring Connections*. Check the display contrast. Refer to Section 6.5 *Set LCD Display Contrast Level*.

Display shows a channel status FAULT message.

The LPT-P is in fault mode. If re-calibrating the sensor fails, replace the sensor.

Display shows “Calibration Failure”.

The span calibration failed. Try to recalibrate the sensor again. If re-calibrating the sensor fails, replace the sensor.

LPT-P powered up (display appears normal) but the control panel displays “Fault”.

Modbus® output signal has not been connected properly. Check the connections and refer to the Wiring Examples in Section 5.6 Wiring Connections.

LPT-P Device cannot be seen by the Controller and/or the BAS / DDC on the Modbus® network.

- Check the Baud rate. All devices in the network must have the same Baud rate. Refer to Section 6.7.2 *Change Modbus® Baud Rate*.
- Check the Modbus® ID. Each device must have a unique ID assigned to it. Refer to Section 6.7.1 *Change Modbus® ID*.
- Check that local area network wiring is correct, especially the A and B lines to make sure they are not swapped between devices on the network.
- Check that local area network wiring is correct, especially the A and B lines to make sure they are not swapped between devices on the network.

Frequent, unexpected alarm conditions. Check to see if EMI and RF interference is causing the equipment to react this way. Refer to Section 5.4.2 *EMI and RF Interference Considerations* for more information.



Critical Environment Technologies Canada Inc.

Unit 145, 7391 Vantage Way, Delta, BC, V4G 1M3, Canada

Toll Free: +1.877.940.8741

Tel: +1.604.940.8741

Fax: +1.604.940.8745

www.critical-environment.com

