



---

# Portable Oil Steel Dust Checker

## Model SDM-73

---

### Instruction Manual

---

- Please keep this instruction manual available for quick reference when needed.
- Before use, carefully read this instruction manual and fully understand the content.



**NEW COSMOS ELECTRIC CO., LTD.**

## - TABLE OF CONTENTS -

1.	Introduction	1
2.	Features	1
3.	Safe Operation	2
4.	Component Names and Functions	
	4-1. Exterior View	3
	4-2. Component Names and Functions	4
5.	Operation Procedures	
	5-1. Installing Batteries	5
	5-2. Battery Check	6
	5-3. Measurement	7
	5-4. Collection of Oil Sample	9
6.	Troubleshooting	10
7.	Specifications	12
8.	Warranty	13
<b>Appendix</b>		
	1. Measuring Principle	14
	2. Metal Materials Measurable	15
	3. Practical Use	16

# **1. Introduction**

---

We thank you for purchasing the Portable Oil Steel Dust Checker Model SDM-73 for the measurement of steel dust in the lubricating oil.

The Oil Steel Dust Checker employs a magnetic balance type electromagnet induction method as the measuring principle, and is a useful simplified diagnosis tool for the inspection of the abrasion status of the bearings and gears, cylinders, etc.

The steel dust can be measured simply by collecting from the oil sample in a sampling syringe.

This Manual describes the specifications, functions and operating instructions, carefully read and thoroughly understand this manual before operating the Oil Steel Dust Checker SDM-73.

# **2. Features**

---

- ◆ The employed magnetic balance type electromagnetic induction method is a highly sensitive for the detection of the abrasion in the initial stage.
- ◆ Suitable for diagnose of irregularity in the ultra slow speed revolution range where diagnosis by vibration method is difficult.
- ◆ Very simple operation.  
Only requiring the sampling container to be filled with the sampled oil and inserted for instant measurement.
- ◆ Compact portable instrument and useful for field measurement.

### 3. Safe Operation

---

Read and understand the contents of the manual before operating the instrument. The following safety symbols are used in this manual and must be observed without fail:

 **Warning** WARNING indicates a situation, which if not avoided, could result in malfunction or abnormal performance of the instrument.

 **Caution** CAUTION indicates a situation, which if not avoided may cause damage to the instrument, or an accurate measurement may not be obtained.

**Memo** MEMO indicates operational advice and or instructions.

#### **CAUTION**

- This instrument is not explosion-proof. It must be used in a safe location.
- Remove the batteries and store the instrument if it is not be used for a long time.
- Do not disassemble or modify the instrument or change the structure or electric circuits.
- Do not leave the instrument in high-temperature or highly humid places.
- Keep the instrument away from radical temperature or humidity changes, walkie-talkie, mobile phone, or its performance may be adversely affected.
- Do not drop, hit, or apply a strong mechanical shock to the instrument, or its performance may be adversely affected.
- This instrument is not drip-proof. Keep the instruments away from water.
- Do not wipe the instrument with a wet cloth or cloth containing a solvent. Wipe the instrument gently with a soft cloth when it is dirty.
- Be sure to keep the sample insert port clean. Correct reading can not be obtained when it is smeared with oil, etc. as there is an optical sensor to detect the sampling syringe. (Wipe away a smear with a cotton swab or soft cloth.)

## 4. Component Names and Functions

### 4-1. Exterior View

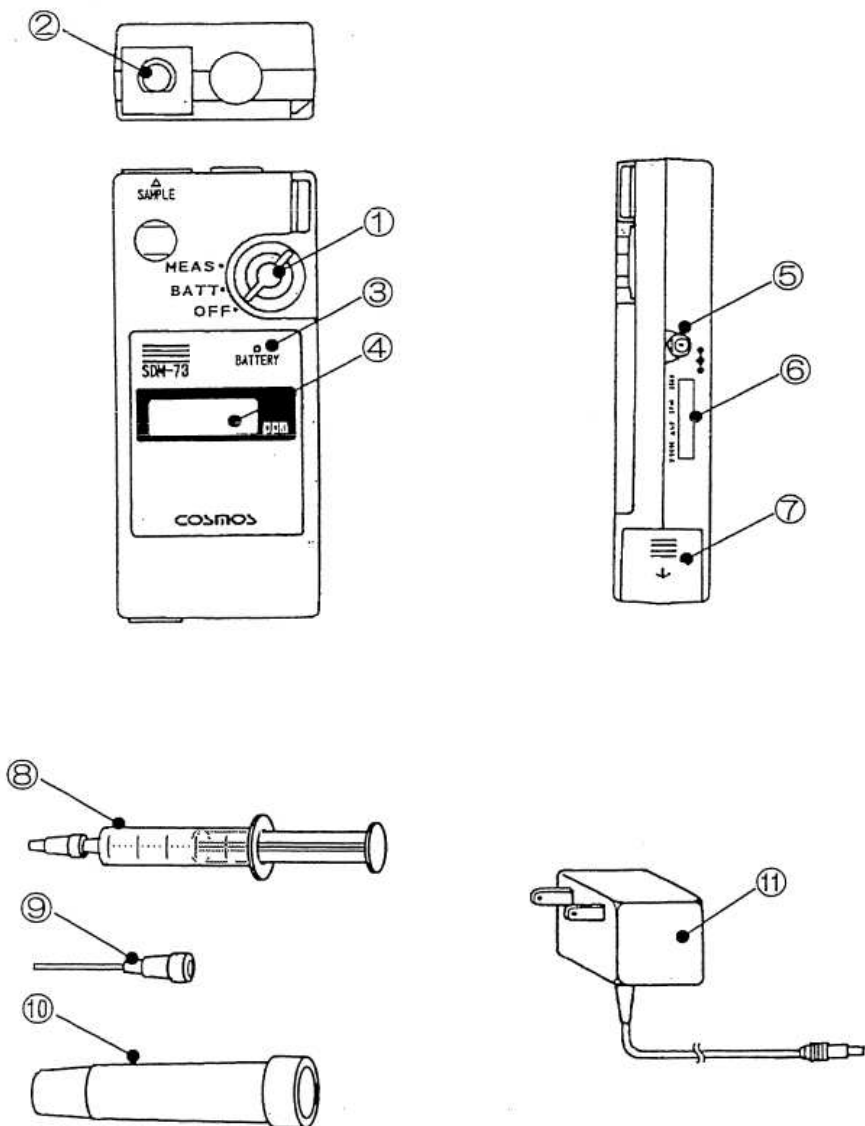

## 4-2. Component Names and Functions

No.	Controls	Functions
1	Change-over selector switch	Rotate the switch to “MEAS” position to commence measurement, with the sampling syringe removed from the instrument. To check the voltage level of the batteries, rotate the switch to “BATT” position.
2	Sample insert port	Insert port for sampled oil. The measurement of the steel dust is conducted when the sampling syringe is inserted, while the selector switch is set at “MEAS” position.
3	BATTERY alarm lamp	To indicate the low battery status, when the battery voltage becomes lower than 3.6V, the alarm lamp will turn ON.
4	LCD display	The display will indicate a digital reading of the steel dust in the sampled oil. Also, to indicate the reading of battery voltage.
5	DC jack	The exclusive jack to accept the plug of the AC Adapter. (Japan only)
6	Calibration date label	Label to indicate calibration date.
7	Battery compartment	The battery compartment accommodates 4 AA size dry batteries.
8	Sampling syringe (2ml)	A syringe to collect sampling oil.
9	Oil collection nozzle	A nozzle for oil collection.
10	Syringe holder	
11	AC adapter	Exclusive AC adapter (option)

# 5. Operation Procedures

---

## 5-1. Installing Batteries

Open the battery compartment cover located on the lower right side of the instrument, press and slide off the cover, secure a fresh set of 4 AA size (LR6) alkaline dry batteries, and carefully observe the battery polarity illustration inside the battery compartment to make sure that the batteries are installed correctly. It is recommended that a fresh new set of batteries be installed; do not use a set of partial used and new batteries.

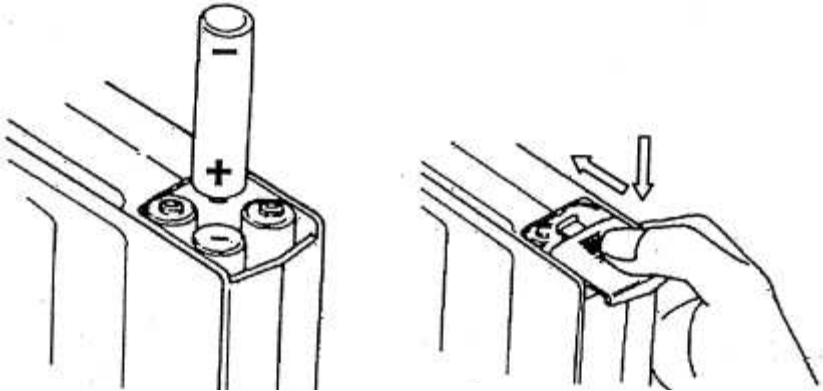

To close the battery compartment, place the cover on the batteries leaving an opening of about 10mm, and while pressing the cover downward push it forward to close the compartment.

## 5-2. Battery Check

Rotate the selector which from the “OFF” position to the “BATT” position, the LCD display will indicate - - - - for a period of 2-3 seconds, then the voltage of the battery will be displayed.

Examples of battery voltage display.

b 5. 6 (Battery voltage = 5.6V)

b 3. 6 can be operated if the voltage is higher than 3.6V

b 3. 6 the BATTERY alarm lamp will turn ON if the voltage is lower than 3.6V and instrument can not be operated. Secure a fresh set of batteries and make replacements.

b 3. 2 when the battery voltage drops below 3.2V, the BATTERY alarm lamp will commence to blinking with an audible buzzer sound.



### Warning

Measurement conducted under low battery condition will not provide an accurate or reliable reading.

### Memo

In case the battery voltage should drop below 3.2V during measurement at “MEAS” mode, the BATTERY alarm lamp will turn ON and the audible alarm will sound.



### Caution

It is recommended to replace the batteries with a fresh set of 4 AA size (LR6) alkaline batteries.



### 5-3. Measurement

- 1) Rotate the selector switch to “MEAS” and shift to the measurement mode.
- 2) Check to see that the display indicates 0.000 then insert the sampling syringe with syringe holder containing the sampled oil into the sample port.  
(Refer to 5.4 regarding procedures for the collection of oil sample.)

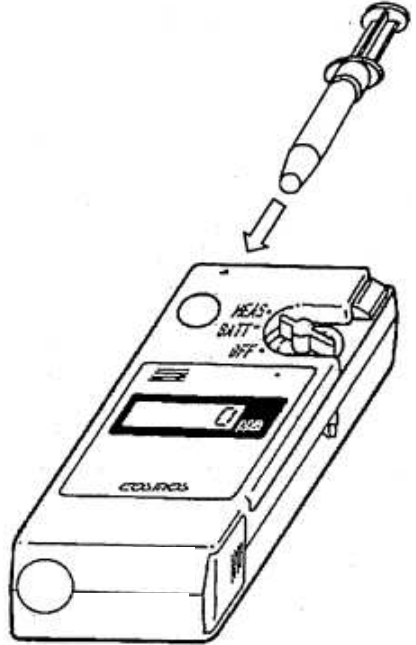

- 3) An audible beep will sound for 2-3 seconds after the sampling syringe with the holder has been inserted indicating the measurement has been completed, and the reading is held, read and record the reading.
- 4) When the sampling syringe with the holder is removed from the sample port, the display will return to zero 0.000 by the auto zeroing adjustment function.  
(Remove the syringe and holder together.)
- 5) After the measurement has been completed, make sure to return the selector switch to “OFF” position.

 **Caution**

- Always insert the sampling syringe with holder, and remove them together gently. Do not apply an impact when inserting the sampling syringe with holder. If the insert is too slow, the reading may drift and may not be accurate. In such case pull out the sampling syringe with the holder once and reinsert for the measurement.
- After the sampling syringe with the holder has been inserted for measurement, do not move the instrument until the “BEEP” sound for the completion of the measurement. If the instrument is moved the measurement may drift.

 **Caution**

- This instrument employs the electromagnetic induction method as the measuring principle, and should not be operated in the vicinity where a strong electromagnetic wave is generated.  
(Example: inverter controlled motor, welding machine, electric spark machine) It is recommended to conduct measurement in a location not effected by such electrical equipment.
- Do not operate the instrument in a location where walkie-talkie or cellular phone may be used.
- During measurement, do not use or place a metal tool (object) near the sample port.
- If the collected sample oil is of high temperature, allow it to cool to normal room temperature before measurement.

**Memo**

- Readings may vary when the size of steel dust is big or when steel dust concentration is high, as the dust in the sampling oil shall be gradually settled. In this case, shake the syringe and mix them well before measurement. It is recommended to measure the value, placing the instrument horizontally.
- Readings obtained from sampling oil with steel dust generated under normal wear are relatively stable. And readings obtained from the oil with steel dust generated under abnormal wear may vary, because size of dust particle is not equal and it affects the measurement.
- Measure the value at least 3 – 4 times and take an average or maximum value, as the reading obtained at 1<sup>st</sup> measurement may be not correct.

#### 5-4. Collection of Oil Sample

- 1) Collect the oil sample (approx. 10-30ml) from rotating portion of the machinery and put it in a sampling bottle. Collect the sampling oil from near bottom since steel dust tends to settle near bottom.
- 2) Shake and mix the oil sample in the sampling bottle well. When the oil viscosity is high, stir the oil well before measurement.
- 3) After mixing the oil sample, collect 1.5ml oil sample in the syringe with oil collection nozzle. Collect slightly larger amount than 1.5ml, and remove the air inside the syringe and adjust the amount equal to 1.5ml.
- 4) Remove the oil collection nozzle and wipe the tip of syringe with paper towel, then fit a cap.
- 5) After shaking the syringe and mix the oil sample well before measurement. Carry out the measurement right after mixing the oil sample.

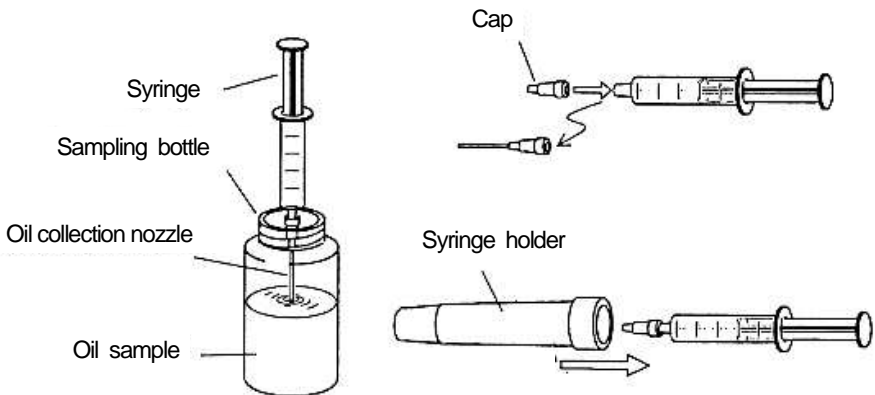

**Memo** Syringe is a consumable part. Pay attention to the following.

- When removing the oil sample stuck on the scale on the syringe, the scale may vanish depending on the type of oil. Do not put oils on the scale on the syringe.
- Discharge the oil sample in the syringe to the sampling bottle after measurement. When it is kept in the syringe, the syringe may be deformed depending on the type of oil.
- Do not put the tip of the syringe downwards after collecting the oil sample in the syringe, since steel dusts may settle in the tip of the syringe.
- The syringe can be used for the measurement 5-10 times. Replace the syringe with a new one when the scale grows faint and hard to read 1.5ml scale.

## **6. Troubleshooting**

Problems, which may be experienced during the use of the Oil Steel Dust Checker SDM-73, are listed in the table below, together with indications of probable cases and recommendations for corrective actions. Contact our authorized distributor if your problem is not listed or when the remedy fails to correct the problem.

<b>Problem</b>	<b>Cause</b>	<b>Remedy</b>
No indication appears on the display when the selector switch is set at "BATT" or "MEAS" using fresh set of batteries.	<ul style="list-style-type: none"> <li>♦ Bad battery contacts.</li> <li>♦ The polarities of the battery are not correctly installed.</li> </ul>	<ul style="list-style-type: none"> <li>♦ Take out the batteries and reinstall. (page 5)</li> <li>♦ Reinstall the batteries with the polarity correctly positioned. (page 5)</li> </ul>
The battery alarm lamp turns ON when selector switch is set at "BATT" or "MEAS" using fresh set of batteries.	<ul style="list-style-type: none"> <li>♦ The battery may be installed with the polarity in wrong position.</li> </ul>	<ul style="list-style-type: none"> <li>♦ Reinstall the batteries with the polarity correctly positioned. (page 5)</li> </ul>
The reading of the display does not stabilize or is not held when the sampled oil is inserted. The reading is held at an unstable condition.	<ul style="list-style-type: none"> <li>♦ The sampled oil is of high temperature and cannot be measured.</li> <li>♦ Measurement conducted nearby a source of strong electromagnet wave. (Inverter controlled motor, etc.)</li> <li>♦ Cellular phone or walkie-talkie used while conducting measurement.</li> </ul>	<ul style="list-style-type: none"> <li>♦ Allow the sampled oil to cool off and conduct measurement. (page 8)</li> <li>♦ Move away from the source of electromagnet wave. (page 8)</li> <li>♦ Turn OFF the cellular phone or walkie-talkie and perform measurement. (page 8)</li> </ul>

<p>Flashing <span style="border: 1px solid black; padding: 2px;">- - - -</span> is indicated on the LCD.</p>	<ul style="list-style-type: none"> <li>♦ Turned Power ON with the sampling syringe with holder inserted in the instrument.</li> </ul>	<ul style="list-style-type: none"> <li>♦ Remove the sampling syringe with holder from the instrument.</li> </ul>
<p>Even after the sampled oil removed from the sample port, the display will not return to zero, or flashing <span style="border: 1px solid black; padding: 2px;">- - - -</span> is indicated.</p>	<ul style="list-style-type: none"> <li>♦ Optical sensor to detect the sampling syringe is smeared with oil, etc.</li> <li>♦ Only the sampling syringe is removed while the syringe holder is in the instrument.</li> </ul>	<ul style="list-style-type: none"> <li>♦ Wipe away a smear near the sample insert port with a cotton swab or soft cloth.</li> <li>♦ Always remove the sampling syringe together with the syringe holder.</li> </ul>
<p>No reading is obtained after the sampled oil is inserted in the instrument.</p>		

## **7. Specifications**

<b>Items</b>	<b>Specifications</b>	<b>Remarks</b>
Model	SDM-73	
Measuring principle	Magnetic balance type electromagnetic induction method.	
To measure	Concentration of iron particles in the oil.	
Measurement range	0 – 19999 ppm	weight ratio
Display	4 1/2 digit liquid crystal display	
Minimum resolution	1 ppm	0 ppm indicated when the value is less than 5 ppm.
Accuracy	$\pm(10 \%rdg + 10 dgts)$ The analyzed value of standard oil by atomic absorption method	$\%rdg =$ measured value%
Zero adjustment	Automatic adjustment	
Sample volume	1.5 ml	
Power requirement	4 AA size dry batteries	
Battery life	30+ hours of continuous operation	using alkaline batteries
Operating temperature	0 to 40 degrees C	
Dimensions	84W x 40D x 190H (mm)	
Weight	Approximately 480g	
Approval	CE (EMC Directive 2004/108/EC)	

## **8. Warranty**

---

New Cosmos Electric Company Limited (New Cosmos) offers the following as the sole and exclusive limited warranty available to Customer.

This warranty is in lieu of, and customer waives, all other warranties of any kind or nature, expressed or implied, including without limitation, any warranty for merchantability or fitness for a particular purpose. The remedies set forth herein are exclusive.

New Cosmos warrants to the original purchaser and no other person or entity (customer) that gas detection product supplied by New Cosmos shall be free from defects in materials and workmanship for a period of one (1) year from the date of purchase. This warranty does not include consumables, such as fuses, filters, etc. Certain other accessories not specifically listed here may have different warranty periods.

After examination of allegedly defective product return to New Cosmos, with freight prepaid, should the product fail to conform to this warranty, customer's only remedy and New Cosmos's only obligation shall be, at New Cosmos's sole option, replacement or repair of such non-conforming product or refund of the original purchase price of the non-conforming product. In no event will New Cosmos be liable for any other special, incidental or consequential damages or losses of any kind whatsoever, including but not limited to, loss of anticipated profits and any other loss caused by reason of non-operation of the product.

This warranty is valid only if the product is maintained and used in accordance with New Cosmos's instructions and /or recommendations. New Cosmos shall be released from all obligations under this warranty in the event repairs or modifications are made by persons other than its own or authorized service personnel or if the warranty claim results from physical abuse or misuse of the product.

# Appendix

---

## Reference Materials

### 1. Measuring Principle

The measuring principle of the magnetic balance electromagnetic induction method is shown in the illustration below, the magnetic circuit sensor is composed of an exciter coil connected to the both sides of the detection coil, the magnetic field generated by both exciter coils are blanketed in the vicinity of the center detection coil.

Normally, the center detection coil does not generate an induction voltage, on the other hand when the sampled oil containing iron particles is inserted into the exciter coil, the magnetic field is offset by the magnetic permeability variation, and an induction voltage is generated in the detection coil. The induction voltage can measure the concentration of the iron particles in the sampled oil.

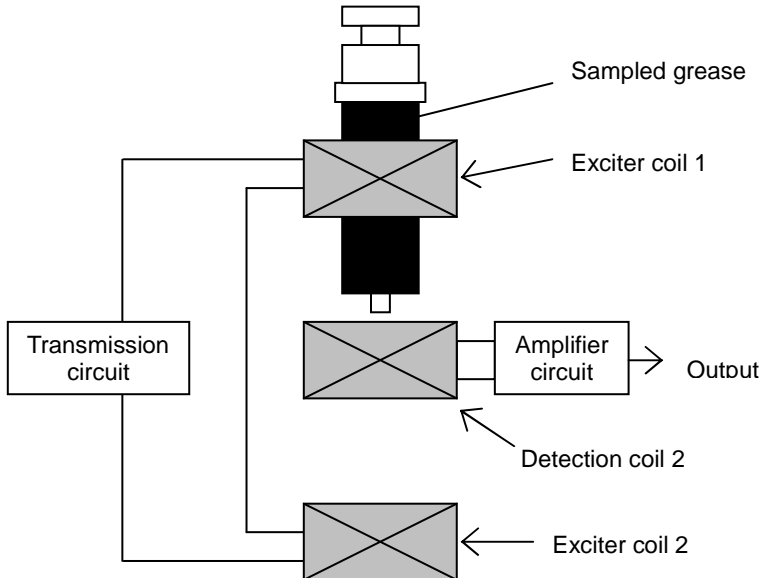



## 2. Metal Materials Measurable

Table 1 of Metal Materials that can be Measured

(○:Measurable, ×:Not measurable)

Metal and Materials	Magnetism	Measurable	Remarks
Iron, nickel, cobalt	Ferromagnetism	○	
Aluminum, chrome, manganese, titan, stainless steel (SUS-304, SUS-316)	Para magnetism	×	
Copper, silver, lead, zinc, tin	Diamagnetic	×	
Iron oxide ( $\alpha$ -Fe <sub>2</sub> O <sub>3</sub> ) Ferruginous (Hydroxide iron)	Para magnetism	×	*1
Iron oxide ( $\gamma$ -Fe <sub>2</sub> O <sub>3</sub> , Fe <sub>3</sub> O <sub>4</sub> )	Ferromagnetism	○	
Sodium, calcium, lithium, molybdenum	Para magnetism	×	*2

\*1: Iron oxide has several isomers, as can be noted from the table above there are substance that can be measured with the Oil Steel Dust Checker and substance that can not be measured. Specially in case the environment allows the oxidation of iron particles easily and where the collected sample contains red rust the measurement conduct may indicate a reading lower than the actual concentration.

### 3. Practical Use

#### 1) Management and Simplified Diagnosis of Oil Lubricated Bearings & Gears

- ◆ To be used to diagnose the steel dust contents in the oil used for lubrication of low speed rotation to high speed rotation machinery. Most useful for the diagnosis of the abrasion of the bearing and gears used at low speed rotation and difficult to diagnose with the vibration method, and to improve the accuracy of diagnosis when jointly used with the vibration method for medium and high speed rotation machinery.
- ◆ Preliminary diagnosis for SOAP method, ferrography method, etc. Useful tool for preliminary diagnosis as a cost saving for maintenance.
- ◆ Example of various use

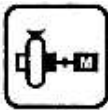

Pumps & Motors

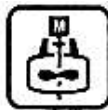

Agitators



Fan-blower · Compressor

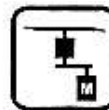

Cooling tower · Air fin cooler



Mixer · Kneader

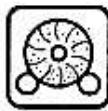

Rotary drier

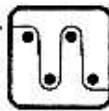

Paper-marking machinery



Mill · Crusher · Refiner

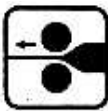

Metal rolling machinery



Conveyor



Crane · Hoist · Lift



Civil engineering machinery



Rolling stock · Transportation



Elevator



Escalator · Moving sidewalk



Parking tower

## 2) Criterion

The following table is an example of the criterion.

This criterion is relatively strict in order to carry out appropriate corrective lubrication improvements, to detect the abnormal trend at an early stage.

The criterion for the small sized machine is three times higher than the one for the large sized machine. It is because oil bath type lubrication and less filtering are frequently employed on the small sized machine.

It is recommended to establish a suitable criterion to your machine, by collecting the data and tendency from the machine although it may sometimes be difficult as there are so many types of machines and applications.

Table 3 Criterion of the Steel Dust Concentration in the Oil

	Criterion (ppm)		Countermeasure
	Large sized machine	Small sized machine	
Normal value	Less than 30	Less than 100	Management of steel dust contents in the oil at normal cycle
Precaution value	30- 100	100- 300	Repeat lubrication and remeasure the steel dust concentration 1 month later.
Irregular value	More than 100	More than 300	Countermeasure for improvement of lubrication, precision diagnosis at short cycle management.

## Manual Revision History

<b>Edition No.</b>	<b>Date</b>	<b>Change</b>
SDM-73 CEET	June, 2008	

Additional copies of this operation manual are available.  
Contact the following address for ordering information.

**Distributor:   Manufacturer:**

New Cosmos Electric Co., Ltd.

2-5-4 Mitsuiya-naka,

Yodogawa-ku,

Osaka 532-0036, Japan

TEL: +81-6-6309-1505

FAX: +81-6-6308-8129

<http://www.new-cosmos.co.jp/en/index.html>