

■ **XP-3110**

(Combustible gases and vapors detector)

■ **XP-3140**

(High concentration gas detector)

■ **XP-3160**

Portable Gas Detector Instruction Manual

This instruction manual explains to the use of three models listed on the left

- Please keep this instruction manual available for quick reference when needed
- Before use, carefully read this instruction manual and fully understand the content.

CE



NEW COSMOS ELECTRIC CO., LTD.

Table of Contents

Contents of This Package	1
1. Introduction	2
Explosion-proof Precautions	2
Explanation of Symbols	2
Safe Operation	3
2. Component Names and Functions	4
3. Operating Procedure	7
Procedure	7
Gas Alarm	10
Functions and Settings Methods	11
Peak Hold Settings	12
Alarm Buzzer Silence Settings	13
Changing the Sample Gas	14
Logging	15
Data Logger Communications Screen	16
Time Settings	17
4. Error Message (Malfunction Alarm)	18
5. Replacement of Consumable Parts	19
Filter Element Replacement	19
Battery Replacement	20
6. Maintenance Inspection	21
Daily Inspection.....	21
Regular Inspection	21
Main Replacement Parts.....	21
7. Troubleshooting	22
8. Warranty	23
9. Specifications	24
10. Markings of explosion-proof	25
11. Detection Principle	26
12. Glossary	27

-Unpacking-

The following standard components are packed together with the Gas Detector. Carefully check the contents against the list when unpacking. If any components are missing or damaged, contact your New-Cosmos Electric representative. A replacement for the missing or damaged component will be sent to you.

Portable Gas Detector (with carrying case)	1
Shoulder belt	1
1-m gas sampling hose (with drain filter and suction pipe)	1
Two spare filter elements (FE-2)	1
AA alkaline batteries (Toshiba LR6)	4
Instruction Manual	1
Warranty	1
Inspection report	1
Operating instruction card	1

Optional items (separately sold)

Log Data Collection Set * Software (CD-R) USB cable (1.8 m) provided	1
--	---

*A PC satisfying the following conditions is required.

OS: MS-Windows^(R) XP

(Gas Detector operation has not been confirmed in other OS versions.)

Hard disk: Free space of 6 Mbytes or more

CD-ROM drive: A CD-ROM drive capable of reading CD-R data

(The software is provided in a CD-R disc.)

USB port: A USB1.1 or higher grade port available to Windows, which allows connection with connector type A.

1. Introduction

Thank you for purchasing the XP-3000 series Portable Gas Detector. To ensure proper use, please read this operation manual thoroughly before using the product to prevent gas accidents and to conduct maintenance inspections.

Be sure you fully understand this manual regardless of whether you have used a Gas Detector before or not. Do not use the product in ways not described in the manual.

The following three types of XP-3000 series Portable Gas Detectors are available.

Product	Model number	Feature
Combustible Gas Detector	XP-3110	Measures combustible gas concentration in a range of 0% to 10% or 0% to 100% (LEL).
High-concentration Gas Detector	XP-3140	Measures high-concentration gas in a range up to 100 vol%.
High-sensitivity Gas Detector	XP-3160	Highly sensitive and ideal for gas detection in ppm.

Explosion-proof Precautions





Follow the explosion-proof XXXXXXXXXXXX.

Operating conditions:

- Replace batteries only in area know to be NON-HAZARDOUS.
- Use the Gas detector in the carrying case specified by New-Cosmos Electric.
- As a comprehensive measure for the prevention of danger resulting from static electricity.
It is desirable for the user carrying the Gas Detector to wear antistatic clothing and electrically conductive shoes(antistatic work shoes). The floor should also be electrically conductive(with an electrical leakage resistance of 10 M Ω or less.)
- In the measurement of the oxygen density, do not use the Gas Detector for any mixtures other than air mixed with combustible gas or steam mixed with toxic gas.
- Warning-Substitution of components may impair intrinsic safety
- Use only Panasonic LR6XJK, Toshiba LR6, or Duracell MN1500 batteries
- Warning-Do Not Replace Batteries when an explosive gas atmosphere may be present
- Warning-Potential Electrostatic Charging Hazard-Do not remove leather case in a hazardous location
- Warning-Do not connect anything to the USB port when an explosive gas atmosphere may be present(Um=5.5V)

Explanation of Symbols

The following symbols are used for safety purposes:

-  **DANGER** : Indicates a hazardous situation that, if not avoided, could result in serious injury or death.
-  **WARNING** : Indicates a potentially hazardous situation that, if not avoided, could result in serious injury or death.
-  **CAUTION** : Indicates a potentially hazardous situation that, if not avoided, could result in minor injury or physical damage.
-  **Note** : Indicates operational advice and/or instructions.

1. Introduction (continued from previous page)

■ Safe Operation

In order to use the Gas Detector safely, be sure to observe the following items.



DANGER

- If the gas alarm turns ON, immediately take all necessary measures to prevent explosion accidents.



WARNING

- Be sure to turn ON the Gas Detector in clean air. Zero calibration is done automatically. Therefore, the wrong gas concentration will be displayed if zero calibration is done in a gas atmosphere.
- Do not close the suction port or exhaust port, or no gas detection will be possible.
- Use the filter element in a clean state. Normal detection cannot be performed if the filter element is dirty or moisture adheres to the filter element.



CAUTION

- Remove the batteries and store the Gas Detector if it is not to be used for a long time.
- The Gas Detector has an explosion-proof construction. Do not disassemble or modify the Gas Detector or change the structure or electric circuits of the Gas Detector. Otherwise, the explosion-proof performance of the Gas Detector will be damaged.
- Do not leave the Gas Detector in high-temperature or highly humid places, or the performance of the Gas Detector may be adversely affected.
- Keep the Gas Detector away from radical temperature or humidity changes, walkie-talkie, mobile phone, or its performance may be adversely affected.
- Keep the Gas Detector away from great atmospheric pressure changes, or the performance of the sensor may be adversely affected or the sensor may be damaged.
- Do not drop, hit, or apply a strong mechanical shock to the Gas Detector, or its performance may be adversely affected.
- The Gas Detector is not drip-proof but the leather case protects the Gas Detector from water drips. Keep the Gas Detector away from water drips as much as possible.
- Keep the Gas Detector away from places close to where silicone sealing materials are being used or silicon gas atmospheres, or its performance may be damaged.
- Do not let the Gas Detector draw in water.
- Do not use any batteries other than the specified one. otherwise it would damage the explosion-proof performance.

***Special Instruction and Warning :**

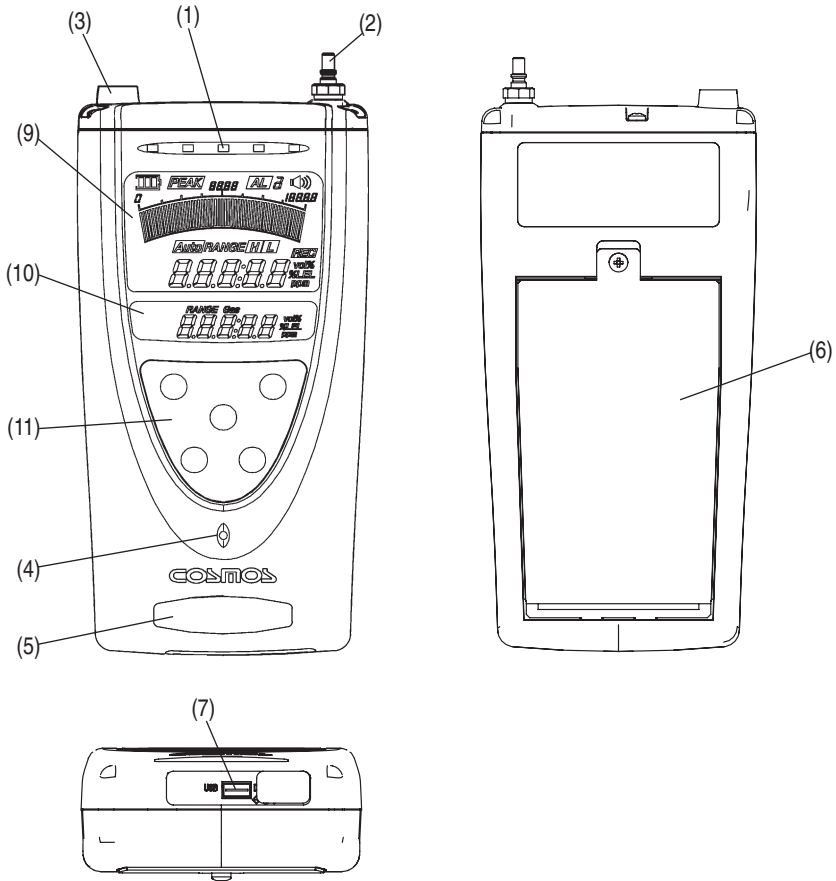

Use Panasonic LR6XJK, Toshiba LR6, or Duracell MN1500 batteries. Use of any other manufacturer or type will violate intrinsic safety requirement. Remove and replace the batteries only in areas known to be non-hazardous.

2. Component Names and Functions

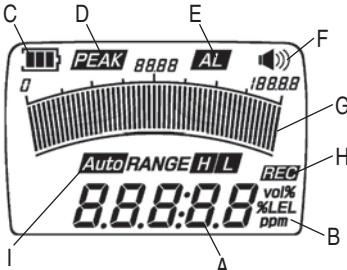

No.	Name	Function
1	Alarm lamp	Flashes at the time of gas alarming.
2	Gas sampling pipe connection port	Connects to the gas sampling hose.
3	Exhaust port	Exhausts sampled gas.
4	Buzzer opening	Sounds a buzzer.
5	Gas type seal	Displays the model number and the types of detectable gases.
6	Battery cover	The cover for the battery compartment.
7	USB connector	Connects to a USB cable (optional item).

2. Component Names and Functions (continued from previous page)

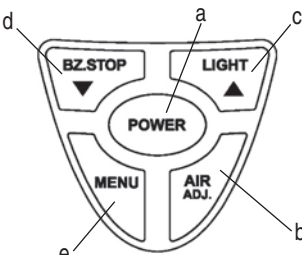
No.	Name	Function
9	<p>LCD main screen</p> 	<p>Displays gas concentration and a variety of messages.</p> <p>A. Displays gas concentration. B. Displays the unit of measurement. C. Displays the remaining battery level. D. Displays peak hold values if the peak hold function is set. E. Displays at the time of a gas alarm. F. Indicates that the alarm buzzer sounds at the time of a gas alarm. G. Displays gas concentration in bar graph form. H. Indicates that the Gas Detector is logging (saving data in memory). I. Displays the range of the bar graph.</p>
10	<p>LCD sub screen</p> 	<p>Displays gas concentration and messages.</p> <p>J. Indicates time. K. Displays a gas number confirmed if the number of detectable combustible gases is two or more.</p>
11	<p>Control panel</p> 	<p>a. Used to turn the Gas Detector ON and OFF Used to change range selections in the gas concentration screen.</p> <p>b. Used for automatic zero calibration.</p> <p>c. Used to turn ON the backlight.</p> <p>d. Used to stop the alarm buzzer.</p> <ul style="list-style-type: none"> Used to check gas numbers if the number of detectable combustible gases is two or more (with no alarm). Used to make an alarm point check with the button continuously pressed. <p>e. Used to make function settings.</p>

2. Component Names and Functions (continued from previous page)

1-m gas sampling hose

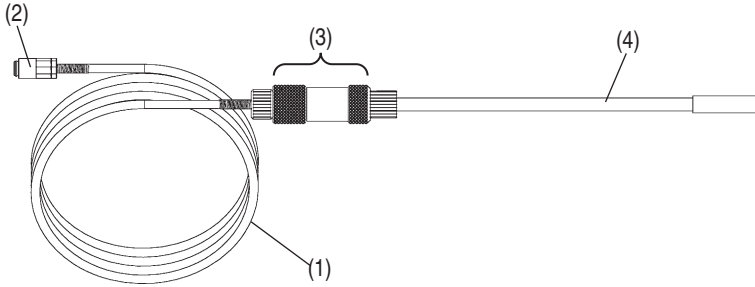

No.	Name	Function
1	Gas sampling hose	Leads gas to the Gas Detector. (1 m long)
2	Coupler	Connects to the Gas Detector.
3	Drain filter (DF-4)	Prevents the penetration of water and dust into the Gas Detector. The filter element (FE-2) is mounted.
4	Suction attachment pipe (AT-3A)	Gas suction port.

Soft case

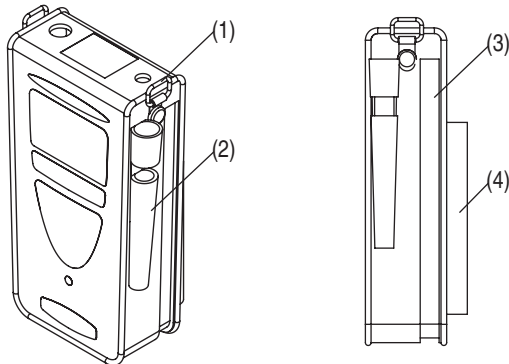

No.	Name	Function
1	Shoulder belt mounting bracket	Connects to the provided shoulder belt.
2	Sampling pipe holder	Holds the suction attachment pipe.
3	Fastener	Used to extract the Gas Detector or replace the battery.
4	Back pocket	Used to hold the sampling hose or provided filter.

3. Operating Procedure

■ Procedure



WARNING

Be sure to conduct a daily inspection before performing detection work (see page 21).

Procedure

1

Insert the batteries.



2 Turn ON the Gas Detector.

Warms up.

Displays the gas concentration screen.



3 Detects



4 Turn OFF the Gas Detector

1. Inserting Batteries

The Gas Detector is delivered without batteries inserted. Refer to pages 20 to insert the provided batteries.

2. Turning Gas Detector ON → Warming Up → Displaying Gas Concentration Screen



WARNING

Be sure to place the connected gas sampling hose in clean air when turning ON the Gas Detector. Zero calibration is done automatically. The wrong gas concentration will be displayed if zero adjustment is done in gas atmosphere.

- (1) Press the POWER switch. The buzzer will beep and the Gas Detector will be turned ON.
- (2) The LCD main screen will display Adj and the bar graph will count down while the Gas Detector is warming up. The LCD sub screen will display Time.
- (3) When the sensor is stabilized, the buzzer will beep and the gas concentration screen will be displayed.

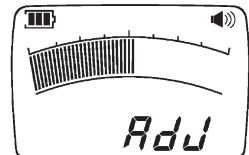

CAUTION

Even after displaying the gas concentration screen, zero indication might be unsettled and flash. In that case, wait for three minutes and conduct zero adjustment (refer to page 9).

Note

If an error message is displayed, refer to Error Messages on page 18.

3. Operating Procedure (continued from previous page)

3. Detection

- Gas Concentration Screen

Gas is detectable when the gas concentration screen is displayed.

The LCD sub screen will display Time.

→ Refer to page 10 for information on the gas alarm.

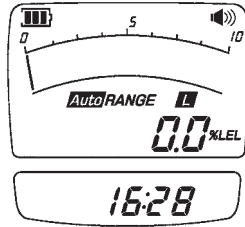

〈Gas Concentration Screen〉

Note

If it is difficult to see the LCD at night, press the LIGHT switch and turn ON the LCD backlight. The backlight will turn OFF in approximately 30 seconds.

- Sample Gas Check Method

If the number of detectable combustible gases is two or more, the gas number can be confirmed by pressing the BZ.STOP switch. The screen will return to the clock display in approximately three seconds. To change the sample gas, refer to page 14.

*The gas number, however, cannot be confirmed during a gas alarm.

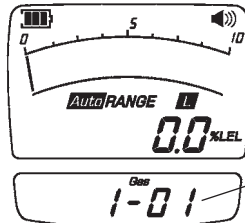

Gas number

Note

The operating instruction card provided with the Gas Detector shows the gas numbers and corresponding detectable gases if the number of detectable combustible gases is two or more.

3. Operating Procedure (continued from previous page)

- Zero adjustment

To conduct zero adjustment, press the AIRADJ. switch for approximately three seconds. The buzzer will then beep once, followed by two beeps after a short pause. If zero adjustment fails, the buzzer will beep once followed by continuous beeps. This means that a gas in the air is affecting the Gas Detector. In that case, conduct zero adjustment in clean air. The sensor may not operate stably, depending on the environment, or if the Gas Detector has not been used for a long time. If that is the case, the gas concentration value will flash. If the value flashes, be sure to conduct zero adjustment, or the precise measurement of gas may not be possible.

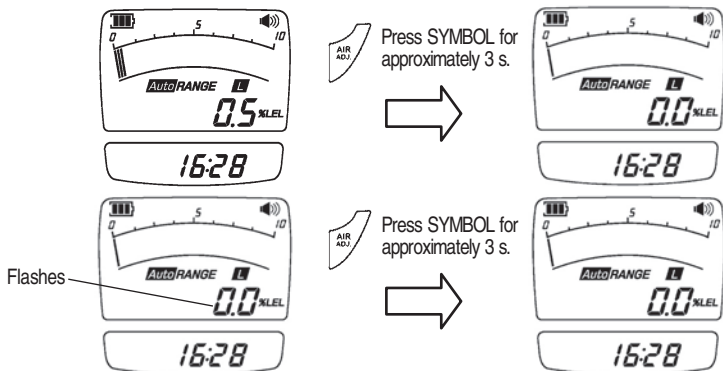

Completion of zero calibration

- Range

To change the bar graph range, press the POWER switch while the gas concentration screen is displayed. The range will be set to AUTO by default when the Gas Detector is turned ON. Each time the POWER switch is pressed, the display will show the next range in the order of H, L, and AUTO.

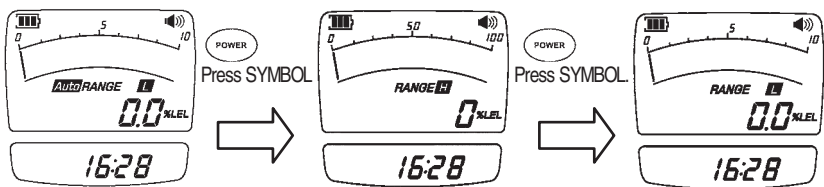

<AUTO range>

When gas is detected, the digital numeric value and the bar graph level will increase simultaneously.

If the bar graph level exceeds the full scale, the range will change from L to H automatically and the scale of the bar graph will change. Furthermore, if the gas concentration drops, the range will automatically return to L.

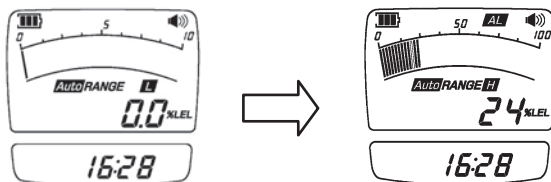

3. Operating Procedure (continued from previous page)

3. Turning Power OFF

CAUTION To turn OFF the Gas Detector, wait until the gas concentration drops in a clean air.

When the POWER switch is pressed for approximately three seconds, the buzzer beeps, and the Gas Detector will be turned OFF.

■ Gas Alarm

If the gas concentration reaches the alarm level, the gas alarm will be turned ON. When the gas concentration drops below the alarm level, the gas alarm will be automatically turned OFF. Only the gas alarm buzzer will stop if the BZ.STOP switch is pressed at the time of a gas alarm. If the gas concentration reaches the alarm level again, the gas alarm buzzer will sound again.

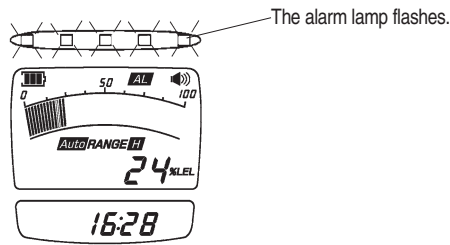

Note If the BZ.STOP switch is continuously pressed while the gas concentration screen is displayed, the alarm point will be displayed for approximately three seconds, and the preset alarm point can be checked.

If the pointer scales out when detecting high-concentration gas, OL will be displayed. High-concentration gas may have an adverse influence on the sensor. Promptly introduce cleaned air into the Gas Detector. Turn OFF the Gas Detector after confirming that the gas concentration falls and the Gas Detector is free of gas.

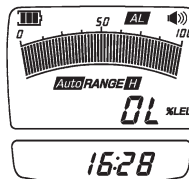

3. Operating Procedure (continued from previous page)

■ Functions and Setting Methods

Press the MENU switch for approximately three seconds on the gas concentration screen. The buzzer will beep once, followed by two beeps after a short pause, and the following settings can be made and executed.

The following settings and execution can be reset by turning OFF the Gas Detector.

Item	Function	Reference page
1. Peak hold function	Continues displaying the peak value of the detected gas concentration.	P. 12
2. Alarm buzzer silencing	The gas alarm buzzer will not sound when the detected gas concentration reaches the alarm level.	P. 13
3. Detectable gas selection	Allows detectable gas selection if the number of detectable combustible gases is two or more.	P. 14
4. LCD selection	This detector can not be set.	
5. Execution and completion of logging	Logs (saves in memory) the detected gas concentration and date. To read the data, a PC (see page 1 for the required conditions) and Log Data Collection Set (optional item) are required.	P. 15
6. Data logger communication	Reads logged data. A PC (see page 1 for the required conditions) and Log Data Collection Set (optional item) are required.	P. 16
7. Time settings	Makes date, month, year, and time settings.	P. 17

Initial menu screen

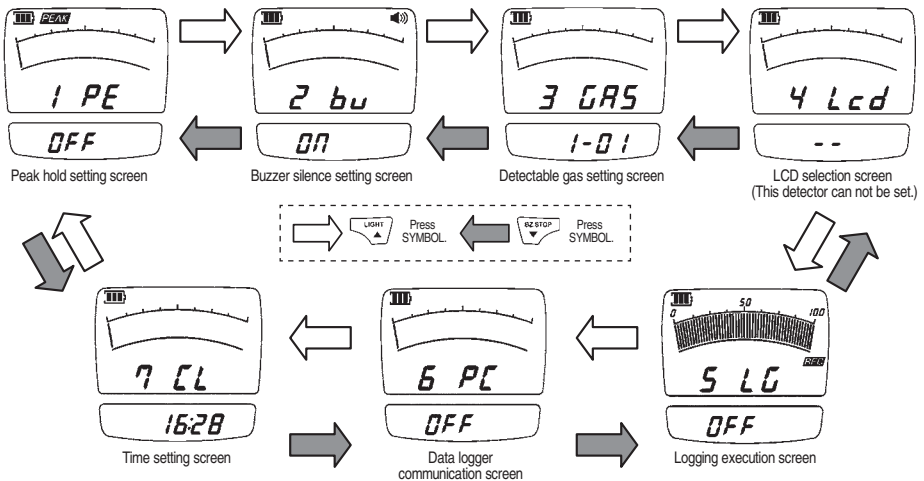

3. Operating Procedure (continued from previous page)

■ Peak Hold Settings

With the peak hold function set, the peak value of gas concentration detected will be displayed continuously.

(1) Press the MENU switch for approximately three seconds while the gas concentration screen is displayed to display the peak hold setting screen (see page 11).

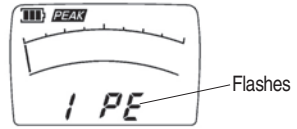

(2) Press the MENU switch to start the peak hold settings. The 1 PE indication will change from flashing to steady illumination, and OFF will change from steady illumination to flashing.



(3) Press the LIGHT switch (▲) to change from OFF to ON.

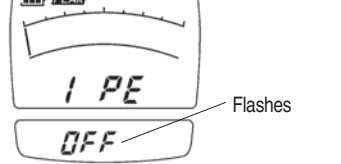

(4) Press the MENU switch to enter the settings. The ON indication will change from flashing to steady illumination, and 1PE will change from steady illumination to flashing.



(5) Press the POWER switch and return to the gas concentration screen. Make sure that PEAK is flashing. To cancel the peak-hold function, take steps similar to the above to turn OFF the function.

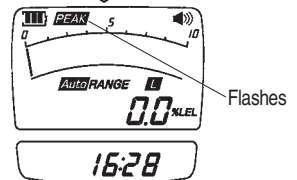
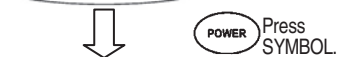
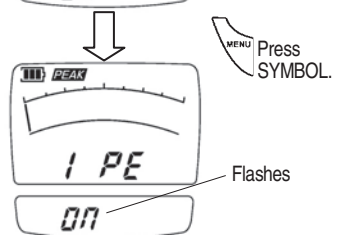
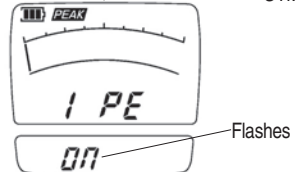

Note The peak hold function can be canceled by turning the Gas Detector OFF, then ON again.

3. Operating Procedure (continued from previous page)

■ Alarm Buzzer Silence Settings

If the alarm buzzer is muted, the alarm buzzer will not sound when the gas concentration reaches the alarm level.

- (1) Press the MENU switch for approximately three seconds to display the alarm buzzer silence screen. Refer to page 11.

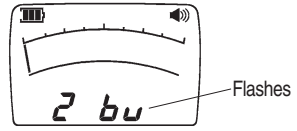

- (2) Press the MENU switch to make the alarm buzzer silence settings.

The 2 bu indication will then change from flashing to steady illumination, and ON will change from steady illumination to flashing.

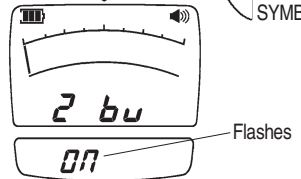

- (3) Press the BZ.STOP switch (▼) and change ON to OFF. [▶▶] will change to [▶].

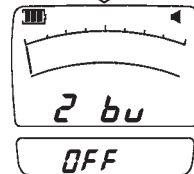

- (4) Press the MENU switch to enter the settings. The OFF indication will then change from flashing to steady illumination, and 2 bu will change from steady illumination to flashing.

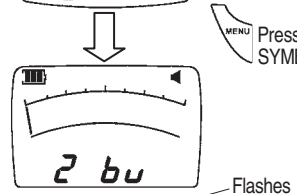

- (5) Press the POWER switch to return to the gas concentration screen.

Take similar steps to change the display OFF to ON in order to cancel the alarm buzzer silencing.

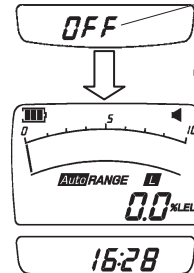

Note The alarm buzzer silence can be canceled by turning the Gas Detector OFF, then ON again.

3. Operating Procedure (continued from previous page)

■ Changing the Sample Gas

Take the following steps to select the type of sample gas if there are two or more detectable gases.

- (1) Press the MENU switch for approximately three seconds while the gas concentration screen is displayed to display the sample gas selection screen. Refer to page 11.

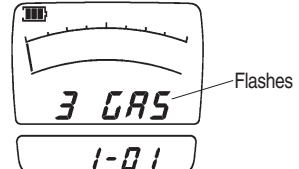

- (2) Press the MENU switch to start the sample gas selection settings.
The 3 GAS indications will then stop flashing, and 1-01 will start flashing.

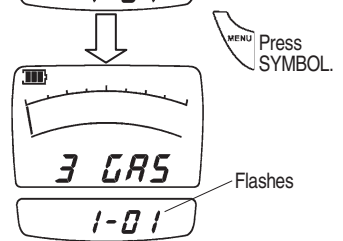

- (3) Press the LIGHT switch (▲) to select the gas number.

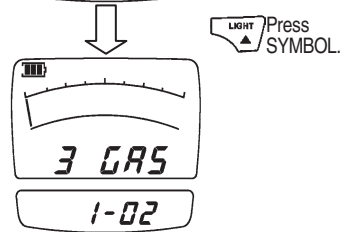

- (4) Press the MENU switch to enter the settings. The 1-02 indication will then change from flashing to steady illumination, and 3 GAS will change from steady illumination to flashing.

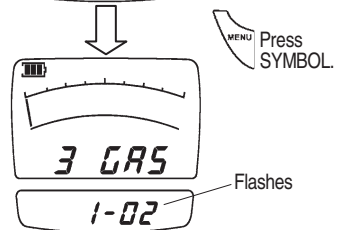

- (5) Press the POWER switch to return to the gas concentration screen.
Press the BZ.STOP switch to display the gas number that has been set. (No alarm.)

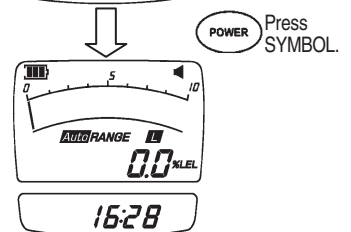

Note

The gas number can be reset to 1-01 by turning the Gas Detector OFF, then ON again.

3. Operating Procedure (continued from previous page)

■ Logging

Take the following steps to log the detected gas.

- (1) Press the MENU switch for three seconds while the gas concentration screen is displayed to display the logging start screen. Refer to page 11.

The bar graph shows the rough possible logging capacity as a percentage. Refer to the operation manual of the Log Data Collection Set for sampling cycle settings.

- (2) Press the MENU switch to begin the logging start setting. The 5 LG indication will then change from flashing to steady illumination, and OFF will change from steady illumination to flashing.

- (3) Press the LIGHT switch (▲) to change OFF to ON.

- (4) Press the MENU switch to enter the settings. The ON indication will then change from flashing to steady illumination, and 5 LG will change from steady illumination to flashing.

- (5) Press the POWER switch to return to the gas concentration screen.

Make sure that the REC indicator is flashing.

To cancel logging, take steps similar to the above and turn OFF the function.

The Gas Detector will stop logging if the Gas Detector is turned OFF, or each error is displayed (see page 18), or the memory capacity is low.

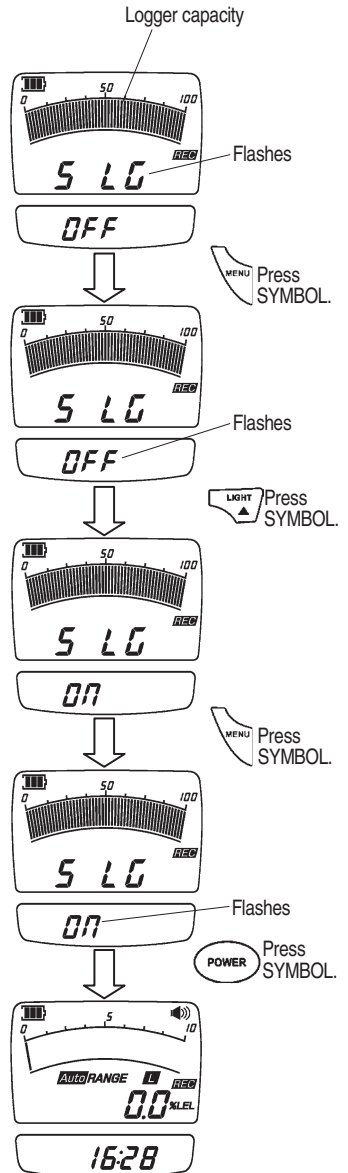

Note

Refer to the operation manual of the Log Data Collection Set for details.

3. Operating Procedure (continued from previous page)

■ Data Logger Communications Screen

Take the following steps to read logging data.

In order to read data, a personal computer (see page 1) and Log Data Collection Set (optional item) are required.

⚠ WARNING Ensure there are no explosive gas atmospheres present before connecting anything to the USB port of the gas detector. For USB port, note that $U_m=5.5V$

(1) Connect a USB cable to the USB connector on the bottom of the Gas Detector.

(2) Press the MENU switch for three seconds while the gas concentration screen is displayed to display the data logger communications screen. Refer to page 11.

(3) When the MENU switch is pressed, OFF will stop flashing and ON will start flashing. Data logger communication with the PC will then be possible. Operate the PC for data logger communication.

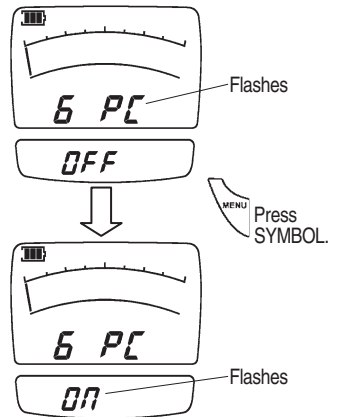

(4) When communication is finished, press the POWER switch twice to return to the gas concentration screen.

Note Refer to the operation manual of the Log Data Collection Set for details.

(5) When finished, replace the gas detector into the case, part No.3620584053, and zip it shut before entering the hazardous location.

3. Operating Procedure (continued from previous page)

■ Time Settings

(1) Press the MENU switch for three seconds while the gas concentration screen is displayed to display the time setting screen. Refer to page 11.

(2) Press the MENU switch to make time settings.
The CL5 indication will then start flashing. Use the BZ.STOP switch (▼) to select the setting unit from Year, Month, Date, Hour, and Minute.

(3) Minute Setting

When the MENU switch is pressed, CL5 will change from flashing to steady illumination, and the minute value will change from steady illumination to flashing.

Use the BZ.STOP switch (▼) or the LIGHT switch (▲) to change the setting and press the MENU switch to enter the value.

(4) Hour Setting

When the MENU switch is pressed, CL4 will change from flashing to steady illumination, and the hour value will change from steady illumination to flashing.

Use the BZ.STOP switch (▼) or the LIGHT switch (▲) to change the setting and press the MENU switch to enter the value.

(5) Date Setting

When the MENU switch is pressed, CL3 will change from flashing to steady illumination, and the date value will change from steady illumination to flashing.

Use the BZ.STOP switch (▼) or the LIGHT switch (▲) to change the setting and press the MENU switch to enter the value.

(6) Month Setting

When the the MENU switch is pressed, CL2 will change from flashing to steady illumination, and the month value will change from steady illumination to flashing.

Use the BZ.STOP switch (▼) or the LIGHT switch (▲) to change the setting and press the MENU switch to enter the value.

(7) Year Setting

When the MENU switch is pressed, CL1 will change from flashing to steady illumination, and the year value will change from steady illumination to flashing.

Use the BZ.STOP switch (▼) or the LIGHT switch (▲) to change the setting and press the MENU switch to enter the value.

(8) Press the POWER switch twice to return to the gas concentration screen.

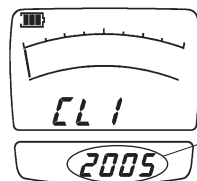
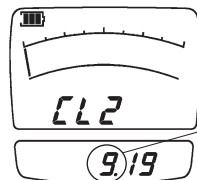
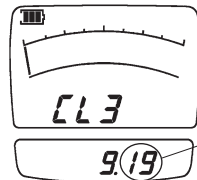
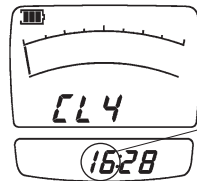
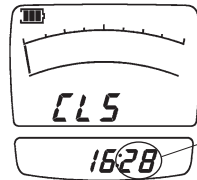
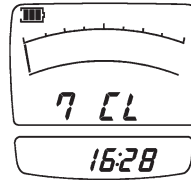

4. Error Messages (Malfunction Alarm)

An error alarm sounds when an error occurs, i.e., the LCD screen displays a corresponding error message and a buzzer sounds. The following table shows the main error messages. Take the necessary remedy according to the error message.

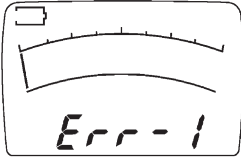
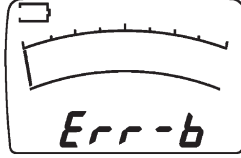
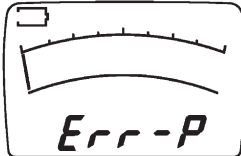
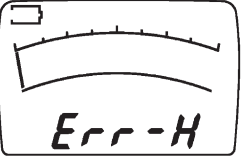
Error message	Remedy
	<p>If the same error message appears again after the Gas Detector is turned OFF and ON several times in a clean air, a sensor error or the end of the sensor lifetime may be considered. Contact your New-Cosmos Electric representative for repairs.</p>
	<p>This message appears when the battery voltage drops and the remaining battery level is low. The Gas Detector will not work when the battery voltage is low. Replace the batteries (see pages 20). Use approved batteries Duracell MN1500, Panasonic LR6XJK or Toshiba LR6.</p>
	<p>The gas sampling hose may have been broken or sucked in water or the suction tip may be clogged. Take the necessary measures, such as eliminating the water (see page 19). If the same error message appears again after the Gas Detector is turned OFF and ON several times, the pump may be broken. If the pump cannot be reset after resetting the batteries or water is drawn into the gas sampling hose or the Gas Detector, contact your New-Cosmos Electric representative for repairs.</p>
	<p>The Gas Detector may be malfunctioning. Contact your New-Cosmos Electric representative for repairs.</p>

5. Replacement of Consumable Parts

■ Filter Element Replacement

If the filter element in the drain filter is dirty or wet or water remains in the drain filter, clean the inside of the drain filter and replace the filter element with a new one.

⚠ WARNING If water is drawn into the inside of the Gas Detector, the Gas Detector cannot detect properly. Contact your New-Cosmos Electric representative for repairs.

- (1) Remove the filter case of the drain filter.
- (2) Use a small flat-blade screwdriver to remove the O-ring in the filter case.
- (3) Replace the FE-2 Filter Element with a new one and reassemble the parts.

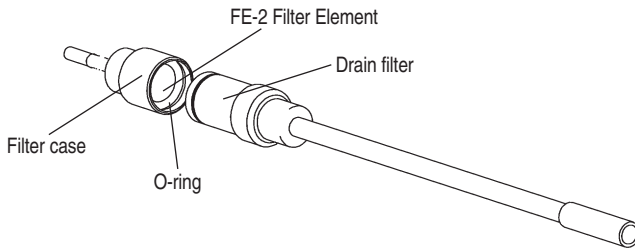

Note

Do not press the filter element with your fingers or other item, or the filter element will be damaged and its filtering performance will be impaired.

5. Replacement of Consumable Parts (continued from previous page)

■ Battery Replacement

When the battery voltage drops and the battery is almost exhausted, the message Err-b will appear and the Gas Detector will not work. Replace the batteries.



WARNING Use Panasonic LR6XJK, Toshiba LR6 or Duracell MN1500 batteries. Use of any other manufacturer or type will violate intrinsic safety requirement. Remove and replace the batteries only in areas known to be non-hazardous.

- (1) Remove a screw on the rear of the gas detector, open the battery cover, and put each new battery to match the polarity of electrodes as shown on the bottom of battery compartment.



CAUTION The battery compartment can accommodate four AA alkaline batteries. Insert the batteries to match the terminal on the side of the compartment.

- (2) Tighten the screw and make sure that the battery cover does not open.

- (3) Insert the gas detector into the case, part No.3620584053, and zip it shut before entering the hazardous location.

Note

Replace all four batteries at the same time with fresh new batteries. Also make sure that the replacement batteries are all the same brand and type.

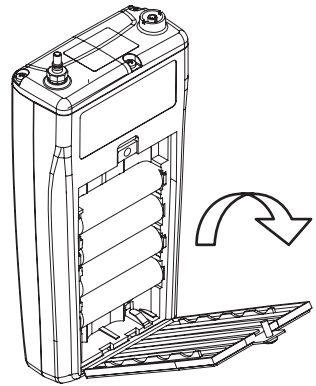
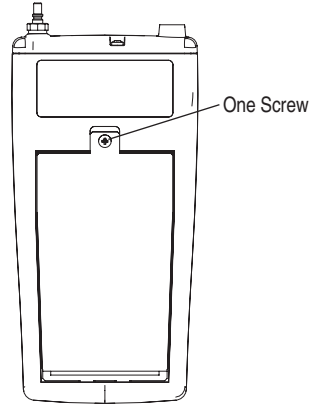

6. Maintenance Inspection

■ Daily Inspection

Check item	Description
Gas sampling hose	Make sure that the gas sampling hose has no bends or damage and that it is securely connected.
Drain filter	If the filter element in the drain filter is dirty or wet or water remains in the drain filter, clean the inside of the drain filter (and 1-m-long gas sampling hose) and replace the filter element with a new one (see page 19).
Remaining battery level	If the remaining battery level is low, replace the batteries with new ones (see page 20).
Airtightness	Press the power switch ON to display the gas concentration screen, cover the gas sampling pipe tip with a finger and check the error message "Err-P"(blockage malfunction) is displayed. As "Err-P" is displayed, it is a normal state and operable by pressing the power switch ON again. if "Err-P" is not displayed the damage of the gas sampling pipe or the airtight defect of the sensor packing or pump diaphragm may be considered. Contact your New-Cosmos Electric representative for repairs or replacements.

■ Regular Inspection

In order to maintain the accuracy of the Gas Detector, request a regular inspection from your New-Cosmos Electric representative.

All XP-3000 series gas detectors which are calibrated have the same algorithm to calculate the measurement data to the concentration.

■ Main Replacement Parts

Product	Model	Remarks
Filter Element	FE-2 (10 filters)	

7. Troubleshooting

Before requesting repairs, please check the items in the following table.

(When the instrument fails to operate, remove all batteries. After several minutes, install the batteries and try again.)

■ Gas detector

Symptom	Cause	Treatment	Page for reference
Power is not turned on even if you press the POWER switch.	The polarity is incorrect.	Install batteries again in the correct polarity.	Battery replacement (P20)
	Battery life	Replace the batteries.	
The buzzer does not sound.	The instrument has been set to the Silent mode.	Deactivate the Silent mode.	Alarm Buzzer Silence Settings (P13)
Gas cannot be detected.	A gas sampling hose has been damaged.	Replace the hose with a new one.	
An error message is displayed on the LCD display.	See the error message (P18)		

8. Warranty

New Cosmos Gas Detection Product Warranty

New Cosmos Electric Company Limited (New Cosmos) offers the following as the sole and exclusive limited warranty available to Customer.

This warranty is in lieu of, and customer waives, all other warranties of any kind or nature, expressed or implied, including without limitation, any warranty for merchantability or fitness for a particular purpose. The remedies set forth herein are exclusive.

New Cosmos warrants to the original purchaser and no other person or entity (customer) that gas detection product supplied by New Cosmos shall be free from defects in materials and workmanship for a period of one (1) year from the date of purchase. This warranty does not include consumables, such as fuses, filters, etc. Certain other accessories not specifically listed here may have different warranty periods.

After examination of allegedly defective product return to New Cosmos, with freight prepaid, should the product fail to conform to this warranty, customer's only remedy and New Cosmos's only obligation shall be, at New Cosmos's sole option, replacement or repair of such non-conforming product or refund of the original purchase price of the non-conforming product. In no event will New Cosmos be liable for any other special, incidental or consequential damages or losses of any kind whatsoever, including but not limited to, loss of anticipated profits and any other loss caused by reason of non-operation of the product.

This warranty is valid only if the product is maintained and used in accordance with New Cosmos's instructions and /or recommendations. New Cosmos shall be released from all obligations under this warranty in the event repairs or modifications are made by persons other than its own or authorized service personnel or if the warranty claim results from physical abuse or misuse of the product.

Request for maintenance

The instrument is a precision instrument. To keep its accuracy, request your New-Cosmos Electric representative for a periodical check at least once a year in addition to daily maintenance. If there is any point which is not clear concerning daily maintenance, please do not hesitate to ask us our agent.

Concerning the repairing of the instrument, please contact our agent. (The cost for sending the instrument to agent will be borne by the customer.)

9. Specifications

■ Gas Detector

Product	Combustible Gas Detector	High-concentration Gas Detector	High-sensitivity Gas Detector
Model	XP-3110	XP-3140	XP-3160
Detectable gases	Combustible gas and combustible solvent steam	Manufacturing gas, natural gas, methane, hydrogen, helium, carbon dioxide, argon, liquefied petroleum gas, butane, and butane air (6A)	Combustible gas and combustible solvent steam
Detection principle	Catalytic combustion type	Thermal conductivity type	Catalytic combustion type
Gas sampling method	Automatic suction type		
Detection range	0% to 100% (LEL)	0vol% to 100vol%	0 to 5,000 ppm 0vol% to 1vol%
Indication accuracy (see note 1)	±5% of FS	H range: ±5% of FS L range: ±10% of FS	H range: ±5% of FS L range: ±10% of FS
Alarm set value	20% (LEL)	50vol%	250 ppm/0.05vol%
Gas alarm method	Buzzer sounds, red lamp flashes, and LCD flashes		
Power supply	Four AA alkaline batteries (LR6) Use DURACELL MN1500 batteries, Toshiba LR6 or Panasonic LR6XJK.		
Continuous operating hours (see 2)	Alkaline batteries: Approx. 20 hrs. Approx. 15 hrs. (Methane specifications)	Alkaline batteries: Approx. 30 hrs.	Alkaline batteries: Approx. 20 hrs. Approx. 15 hrs. (Methane specifications)
	(At an ambient temperature of 20°C with the alarm, backlight, and data logging function turned OFF.)		
Operating temperature and humidity range	0°C to 40°C and 95% max. (with no condensation)		
Explosion proof	DEMKO 12 ATEX 1014729X  II 2 G Ex d ib IIB T4 Gb IECEx UL 13.0012X Ex d ib IIB T4 Gb		
Other major alarms	Remaining battery level, sensor error, and flow rate drop		
Main functions	<ul style="list-style-type: none"> • Zero adjustment Sensor zero adjustment is possible at the time of starting the Gas Detector and at any time while the Gas Detector is on. • Peak hold A peak display of gas concentration is possible. • Buzzer stop A switch to stop a sounding buzzer. • Backlight A switch to turn the backlight ON. • Data logging 		
Size (excluding projections)	Approx. W 82 x H 162 x D 36 mm		
Weight	Approx. 605 g (including alkaline batteries)		
Accessories	Leather case, Shoulder belt, Four AA alkaline batteries, Gas sampling hose (1 m), Spare filter elements (two elements)		
Optional item	Gas sampling hose, Mixer, Log Data Collection Set		

*1. Indication accuracy: Under identical measurement conditions.

*2. The operating time of the batteries depends on factors such as environmental conditions, operating conditions, the storage time, and the manufacturer.

11. Detection Principle

● Catalytic Combustion Type

A catalyst applied to the surface of a platinum coil causes catalytic combustion on the surface of the catalyst even when the gas concentration level is lower than the lower explosion limit.

The temperature rise in this process increases the electrical resistance of platinum coil. This change is picked up as deviation voltage for a bridged circuit. You can detect combustible gases up to the lower explosion limit (LEL).

● Hot-wire Type Semiconductor

When the metal oxide semiconductor heated by the platinum filament adsorbs electron-releasing gas, such as combustible gas, the electron concentration of the combustible gas will increase and the specific thermal conductivity of the semiconductor will increase. As a result, the temperature of the semiconductor will drop and the resistance of the platinum filament will decrease. This resistance change is output as a voltage deviation change of the bridge circuit. The sensor is very sensitive to low concentrations, making it suitable for high-sensitivity detection.

● Thermal conductivity type

This type of detector uses the difference in thermal conductivity between a standard gas and the gas to be detected. When an electrically pre-heated coil of platinum wire is brought into contact with the gas to be detected, heat is absorbed by the gas or vapor, changing the temperature of the coil. This change in temperature is almost directly proportional to the concentration of the gas, and produces a change in the resistance of the platinum coil. This can be measured as a difference in voltage in terms of the output of a bridge circuit. The relationship between the output and the gas concentration is virtually

linear, right up to 100%. This makes this type of sensor suitable for measuring high gas concentrations (0-100vol%).

12. Glossary

Zero adjustment: Zero-point setting in pure air (21 vol% adjustment for Oxygen)

Explosion-proof: A structure applied to electrical equipment to prevent the equipment from igniting the surrounding explosive atmosphere as the source of ignition.

Intrinsically safe design: A structure whose inability to ignite explosive gases with a spark of electricity or a hot section generated in normal time or an accident has been confirmed in fire and other tests.

Flame proof type: A type of protection in which the parts can ignite an explosive atmosphere are to be placed in an enclosure, which can withstand the pressure developed during internal explosion of an explosive mixture, and which prevents the transmission of the explosion to the explosive atmosphere surrounding the enclosure.

Non hazardous area: A place where there is no possibility that an explosive gas will mix with the air under ordinary or abnormal circumstances and reach the explosion limit.

%LEL: Concentrations of combustible gases given in terms of percent of the lower explosive limit.

vol %: Gas concentrations given in terms of percent of cubic volume.

(Partly cited from the Industrial Gas Detectors Monitor Association, Glossary of Gas Detector Alarms, and Glossary of Detection Tube Type Gas Measuring Instrument)

MEMO

● **Loss of the Instruction Manual:**

If this instruction manual is lost, contact New Cosmos Electric or the nearest branch or sales office shown below.

A copy of the instruction manual will be delivered to you. (A fee is charged.)

Distributor/Retail Store



NEW COSMOS ELECTRIC CO.,LTD.

Head Office : 2-5-4 Mitsuya-naka, Yodogawa-ku, Osaka 532-0036 Japan
Phone.(06)6309-1505 Fax.(06)6308-8129

Tokyo Office: 2-6-2 Hamamatsu-cho, Minato-ku, Tokyo 105-0013 Japan
Phone.(03)5403-2715 Fax.(03)5403-2710

URL <http://www.new-cosmos.co.jp>