



THE EDGE PERSONAL NOISE DOSIMETER MODEL EG-4P

WITH (OPTIONAL) BLUETOOTH WIRELESS

USER MANUAL



START SEEING THE BENEFITS OF REGISTERING TODAY!

Thank you for your TSI instrument purchase. Occasionally, TSI releases information on software updates, product enhancements and new products. By registering your instrument, TSI will be able to send this important information to you.

<http://register.tsi.com>

As part of the registration process, you will be asked for your comments on TSI products and services. TSI's customer feedback program gives customers like you a way to tell us how we are doing.



UNDERSTANDING, ACCELERATED

TSI Incorporated - Visit our website **www.tsi.com** for more information.

USA	Tel: +1 800 874 2811	India	Tel: +91 80 67877200
UK	Tel: +44 149 4 459200	China	Tel: +86 10 8219 7688
France	Tel: +33 1 41 19 21 99	Singapore	Tel: +65 6595 6388
Germany	Tel: +49 241 523030		

©2015 TSI Incorporated

Printed in U.S.A.

Manual History

Revision	Date
A	July 2019

(This page intentionally left blank)

Warranty

Part Number

6013118 / Revision A

Copyright

©TSI Incorporated / 2019 / All rights reserved.

Address

TSI Incorporated / 500 Cardigan Road / Shoreview, MN 55126 / USA

Fax No.

651-490-3824

E-mail Address

technical.services@tsi.com

**Limitation of Warranty
and Liability**

(effective April 2014)

Seller warrants the goods, excluding software, sold hereunder, under normal use and service as described in the operator's manual, to be free from defects in workmanship and material for **12 months**, or if less, the length of time specified in the operator's manual, from the date of shipment to the customer. This warranty period is inclusive of any statutory warranty. This limited warranty is subject to the following exclusions and exceptions:

- a. Hot-wire or hot-film sensors used with research anemometers, and certain other components when indicated in specifications, are warranted for 90 days from the date of shipment;
- b. Pumps are warranted for hours of operation as set forth in product or operator's manuals;
- c. Parts repaired or replaced as a result of repair services, excluding the microphone (057-309) are warranted to be free from defects in workmanship and material, under normal use, for 365 days from the date of shipment;
- d. Seller does not provide any warranty on finished goods manufactured by others or on any fuses, batteries or other consumable materials. Only the original manufacturer's warranty applies;
- e. This warranty does not cover calibration requirements, and seller warrants only that the instrument or product is properly calibrated at the time of its manufacture. Instruments returned for calibration are not covered by this warranty;
- f. This warranty is **VOID** if the instrument is opened by anyone other than a factory authorized service center with the one exception where requirements set forth in the manual allow an operator to replace consumables or perform recommended cleaning;
- g. This warranty is **VOID** if the product has been misused, neglected, subjected to accidental or intentional damage, or is not properly installed, maintained, or cleaned according to the requirements of the manual. Unless specifically authorized in a separate writing by Seller, Seller makes no warranty with respect to, and shall have no liability in connection with, goods which are incorporated into other products or equipment, or which are modified by any person other than Seller.

The foregoing is **IN LIEU OF** all other warranties and is subject to the **LIMITATIONS** stated herein. **NO OTHER EXPRESS OR IMPLIED WARRANTY OF FITNESS FOR PARTICULAR PURPOSE OR MERCHANTABILITY IS MADE. WITH RESPECT TO SELLER'S BREACH OF THE IMPLIED WARRANTY AGAINST INFRINGEMENT, SAID WARRANTY IS LIMITED TO CLAIMS OF DIRECT INFRINGEMENT AND EXCLUDES CLAIMS OF CONTRIBUTORY OR INDUCED INFRINGEMENTS. BUYER'S EXCLUSIVE REMEDY SHALL BE THE RETURN OF THE PURCHASE PRICE DISCOUNTED FOR REASONABLE WEAR AND TEAR OR AT SELLER'S OPTION REPLACEMENT OF THE GOODS WITH NON-INFRINGING GOODS.**

TO THE EXTENT PERMITTED BY LAW, THE EXCLUSIVE REMEDY OF THE USER OR BUYER, AND THE LIMIT OF SELLER'S LIABILITY FOR ANY AND ALL LOSSES, INJURIES, OR DAMAGES CONCERNING THE GOODS (INCLUDING CLAIMS BASED ON CONTRACT, NEGLIGENCE, TORT, STRICT LIABILITY OR OTHERWISE) SHALL BE THE RETURN OF GOODS TO SELLER AND THE REFUND OF THE PURCHASE PRICE, OR, AT THE OPTION OF SELLER, THE REPAIR OR REPLACEMENT OF THE GOODS. IN THE CASE OF SOFTWARE, SELLER WILL REPAIR OR REPLACE DEFECTIVE SOFTWARE OR IF UNABLE TO DO SO, WILL REFUND THE PURCHASE PRICE OF THE SOFTWARE. IN NO EVENT SHALL SELLER BE LIABLE FOR LOST PROFITS, BUSINESS INTERRUPTION, OR ANY SPECIAL, INDIRECT, CONSEQUENTIAL OR INCIDENTAL DAMAGES. SELLER SHALL NOT BE RESPONSIBLE FOR INSTALLATION, DISMANTLING OR REINSTALLATION COSTS OR CHARGES. No Action, regardless of form, may be brought against Seller more than 12 months after a cause of action has accrued. The goods returned under warranty to Seller's factory shall be at Buyer's risk of loss, and will be returned, if at all, at Seller's risk of loss.

Buyer and all users are deemed to have accepted this LIMITATION OF WARRANTY AND LIABILITY, which contains the complete and exclusive limited warranty of Seller. This LIMITATION OF WARRANTY AND LIABILITY may not be amended, modified or its terms waived, except by writing signed by an Officer of Seller.

Service Policy

Knowing that inoperative or defective instruments are as detrimental to TSI as they are to our customers, our service policy is designed to give prompt attention to any problems. If any malfunction is discovered, please contact your nearest sales office or representative, or call TSI's Customer Service department at 1-800-680-1220 (USA) or (651) 490-2860.

Trademarks

TSI and the TSI logo are registered trademarks of TSI Incorporated.

MSP is a registered trademark of TSI Incorporated.

Microsoft, Excel, and Windows are registered trademarks of Microsoft Corporation.

The Bluetooth word mark and logos are registered trademarks owned by the Bluetooth SIG, Inc. and any use of such marks by Endress+Hauser is under license.

Apple, the Apple logo, iPhone, and iPod touch are trademarks of Apple Inc., registered in the U.S. and other countries. App Store is a service mark of Apple Inc.

Android, Google Play and the Google Play logo are trademarks of Google Inc.

Contents

MANUAL HISTORY	III
WARRANTY.....	V
CONTENTS.....	VII
SAFETY INFORMATION.....	XI
Labels.....	xi
Description of Caution/Warning Symbols	xii
Caution	xii
Warning	xii
Caution or Warning Symbols.....	xii
Getting Help	xiii
CHAPTER 1 INTRODUCTION	1-1
Dosimetry	1-1
Noise Dosimeter.....	1-2
Range of Sound	1-3
What do the Standards Say?	1-3
Applications of the Edge	1-4
Noise Assessment Steps	1-5
The Edge Model.....	1-6
Virtual Dosimeters	1-6
CHAPTER 2 GETTING STARTED.....	2-1
Checking the Equipment.....	2-1
Turning On	2-2
LED Indicator	2-3
Navigating.....	2-3
Turning Off	2-4
Display and Keypad	2-4
Diagram	2-4
TSI Detection Management Software	2-5
Loading.....	2-5
Docking Station Functionality.....	2-5
Docking Station Components	2-6
EdgeDock1 or EdgeDock5	2-6
Powering EdgeDock1 or EdgeDock5	2-7
Charging your Dosimeter.....	2-7
Mounting the Docking Station to a Wall.....	2-8
Storing the Dosimeter	2-9
CHAPTER 3 SETTING UP THE EDGE VIA DETECTION	
MANAGEMENT SOFTWARE	3-1
Noise Studies	3-1
Understanding What Data is Stored	3-2
Summary Data.....	3-2
Time History	3-2
Logging.....	3-3

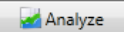
Views on the Edge	3-3
Definitions of Data Log Values and Views	3-4
Edge Measurement Descriptors/Variants.....	3-6
Docking	3-7
Communicating and Downloading Data	3-7
Customizing Set-Up Parameters in Detection Management	
Software.....	3-9
Dosimeter Setting	3-9
Display Setting.....	3-11
Security Setting.....	3-12
Auto Run Setting.....	3-13
Firmware Update	3-14
Saving and Sending/Setting Configurations.....	3-15
CHAPTER 4 RUNNING AND OPERATING YOUR DOSIMETER.....	4-1
Overview of Running a Study	4-1
Positioning the Edge on your Shirt	4-2
Windscreen and Maintenance	4-2
Checking Battery Power	4-2
Calibrating.....	4-3
Resetting the Dosimeter	4-5
Setting Contrast on Dosimeter	4-6
Running Studies.....	4-7
Starting a Run.....	4-7
Stopping a Study.....	4-7
Indicators/Icons on the Display.....	4-8
Viewing Measurements on the Display	4-8
Locking or Securing your Dosimeter During Run	4-9
Locking or Securing	4-9
Unlocking.....	4-9
CHAPTER 5 VIEWING YOUR STUDIES IN DETECTION	
MANAGEMENT SOFTWARE	5-1
Downloading Data.....	5-1
Viewing Data and Data Finder Page.....	5-3
Report View.....	5-4
Panel Layout View (charts/graphs)  	5-5
Quick Tips with Panels (charts/graphs).....	5-6
CHAPTER 6 ADDITIONAL PRODUCT SUPPORT	6-1
LED Indicator: Disable/Enable	6-1
Replacing Microphone and Windscreen	6-1
Attaching/Detaching.....	6-1
CHAPTER 7 MAINTENANCE AND SERVICE.....	7-1
Technical Contacts.....	7-1
Returning for Service	7-2
APPENDIX A SPECIFICATIONS	A-1
Standards.....	A-1
ANSI S1.25 Class Designation	A-1
Mechanical Characteristics	A-1
Electrical Characteristics.....	A-2
Environmental Effects	A-2

User Interface	A-3
Display	A-3
Keypad.....	A-3
EdgeDock1 and EdgeDock5.....	A-3
Physical Attributes of EdgeDock1 and EdgeDock5.....	A-4
Measurements	A-4
Edge Block Diagram	A-7
APPENDIX B GLOSSARY OF TERMS.....	B-1
APPENDIX C MEASUREMENT EQUATIONS.....	C-1
APPENDIX D RADIO APPROVALS PAGE	D-1
Europe.....	D-1
USA	D-1
FCC Caution	D-1
Industry Canada (IC).....	D-2
INDEX	

(This page intentionally left blank)

Safety Information

This section gives instructions to promote safe and proper handling of The Edge Personal Noise Dosimeter Model EG-4P.



WARNING



Protection provided by the equipment will be impaired if not used in a manner specified by the manufacturer.

IMPORTANT

There are no user-serviceable parts inside the instrument. Refer all repair and maintenance to a qualified factory-authorized technician. All maintenance and repair information in this manual is included for use by a qualified factory-authorized technician.

Labels

Advisory labels and identification labels are attached to the outside of the instrument housing and to the optics housing on the inside of the instrument.

1. Serial number label (back panel)	
2. European symbol for non-disposable item. Item must be recycled.	

Description of Caution/Warning Symbols

Appropriate caution/warning statements are used throughout the manual and on the instrument that require you to take cautionary measures when working with the instrument.

Caution



C a u t i o n

Failure to follow the procedures prescribed in this manual might result in irreparable equipment damage. Important information about the operation and maintenance of this instrument is included in this manual.

Warning



W A R N I N G

Warning means that unsafe use of the instrument could result in serious injury to you or cause damage to the instrument. Follow the procedures prescribed.

Caution or Warning Symbols

The following symbols may accompany cautions and warnings to indicate the nature and consequences of hazards:

	Warns that uninsulated voltage within the instrument may have sufficient magnitude to cause electric shock. Therefore, it is dangerous to make contact with any part inside the instrument.
	Warns that the instrument contains a laser and that important information about its safe operation and maintenance is included in the manual.
	Warns that the instrument is susceptible to electro-static dissipation (ESD) and ESD protection procedures should be followed to avoid damage.
	Indicates the connector is connected to earth ground and cabinet ground.

Getting Help

To obtain assistance with this product or to submit suggestions, please contact Customer Service:

TSI Incorporated
500 Cardigan Road
Shoreview, MN 55126 U.S.A.
Fax: (651) 490-3824 (USA)
Fax: 001 651 490 3824 (International)
Telephone: 1-800-680-1220 (USA) or (651) 490-2860
International: 001 651 490 2860
E-mail Address: technical.services@tsi.com
Web site: www.tsi.com

(This page intentionally left blank)

CHAPTER 1

Introduction

Dosimetry

Measuring noise in the workplace is an important element of hearing conservation programs and noise reduction programs. With a noise dosimeter, you can assess and determine a worker's daily exposure to noise levels. This information can be used to ensure compliance with regulatory bodies or to ensure if hearing conservation programs are needed.

To get you started quickly with the Edge, the first chapter is dedicated to introducing basic noise dosimetry terms and information. The subsequent chapters will guide you through setting up the dosimeter, running studies, monitoring progress during the day, and assessing your results with easy to follow steps and illustrations.



Figure 1-1
The Edge and Dosimetry

Noise Dosimeter

What is a noise dosimeter and how does it compute measurements?

Essentially, a noise dosimeter is composed of the following: a microphone with a preamplifier, a weighted network, fast or slow response time, an internal clock, calculator, and memory to store logged data.

The illustration below is a diagram of a basic noise dosimeter. The microphone will, when exposed to a sound pressure, generate an electrical signal. The signal will be increased by a preamplifier, and then is regulated to an applicable level by the range control (dB range). The signal then goes through a filter set or weighting system. The next circuit is the response circuit, which controls the dampening of the readout. The response choices are typically Slow or Fast. Finally, the results will display on the dosimeter screen.

For computation and storage, the clock tracks the sampling time. Dosimeters record how long sound levels exceeded a set upper limit. The calculator computes an L_{avg} , a dose, a TWA, and other data. The memory stores all times, calculations, and measurements.

For post-processing, Detection Management Software is used to view and analyze your measurement results with the option to view and/or print reports.

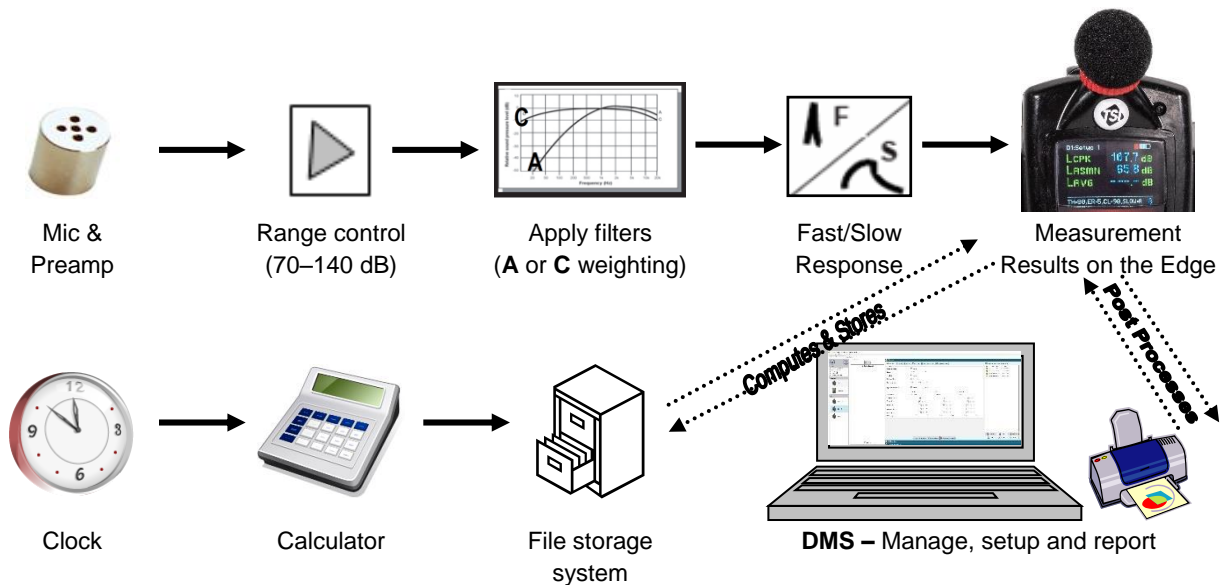

Figure 1-2
Illustration of how the Dosimeter Operates and Processes

Range of Sound

Sound pressure is measured in decibels, or tenths of a Bel. Sound pressure level is indicated as dB SPL. Since the human ear can detect sounds with an extensive range of amplitude, a decibel scale is used to simplify the measurement results. For example, the ratio between the threshold of hearing and threshold of pain in the human ear if measured in true energy is 10,000,000 times! The same range using the dB scale is 0–140 dB referenced to 20 μ Pa (Micropascals).

The quietest sound that humans can hear has an amplitude of approximately 0 dB. Prolonged exposure to sound pressure levels exceeding 85 dB can cause permanent damage to the ear. Sound levels in excess of 130 dB are more than the human ear can safely withstand and can result in serious pain and permanent damage.

What do the Standards Say?

Many organizations have studied and analyzed the effects of high sound exposure on hearing. As a result, standards were developed to regulate personal noise exposure. In the United States, the Occupational Safety and Health Administration (OSHA), the Mine and Safety and Health Administration (MSHA), and the American Conference of Governmental Industrial Hygienists (ACGIH) have all created regulations and limitations on total permissible noise exposure. International standards are specified by the health and safety regulations such as the European Union (EU) Directive 2003/10/EC. Additionally, the International Electrotechnical Commission (IEC) IEC-61252 has specific guidelines and regulations to monitor noise in the workplace.

To access these copyrighted standards, please refer to the following:

- OSHA—<http://www.osha.gov>
- MSHA—<http://www.msha.gov>
- NIOSH—<http://www.cdc.gov/niosh/topics/noise>
- ACGIH—<http://www.acgih.org/>
- IEC—<http://www.iec.ch>

Applications of the Edge

The Edge has a cable-free, mounted microphone that converts sound pressure into an electrical signal. This signal is conditioned, monitored, and integrated over time in order to provide a host of automatically calculated values that can be used in occupational and environmental noise assessments. Programmable parameters permit the Edge to serve many applications. The Edge can be used in the following applications:



- **As a personal noise dosimeter**—used to measure a worker's daily exposure to noise levels. This information can be used to ensure compliance with OSHA, MSHA, ACGIH, IEC, or your own customized parameter settings to determine if your workers are over-exposed to noise.

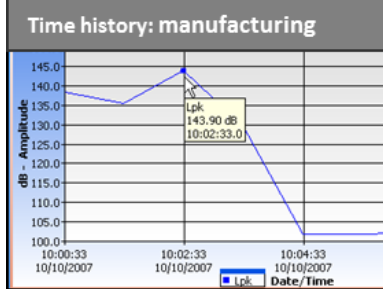

- **As a time-history monitor**—used to provide a worker's minute-by-minute noise exposure levels. This data can help you identify major contributors to the average daily noise exposure.
- **As a survey monitor**
- **Throughout a plant/facility**—used to oversee noise levels throughout an entire facility. You can identify machines and equipment which produce harmful noise levels.
- **Specific areas in a plant/facility**—used to identify key areas as “noisy” and implement noise control options. Employees may be exposed to unacceptable noise levels.
- **As a peak dosimeter**—used to detect the highest level of instantaneous sound pressure.

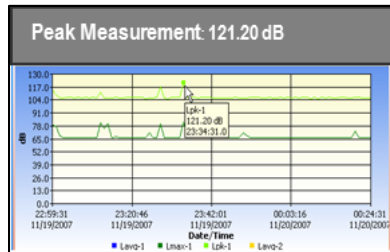

Noise Assessment Steps

1. Perform a task-based work flow analysis of unacceptable “noisy” areas and list regulations/codes you will follow.

- ⊙ Observe facility/areas and jot down areas of concern
- ⊙ Check with standards and noise ordinance regulations in your region/city.
 - ❖ See [Chapter 1](#) for basic information on dosimetry and standards



2. Setting-up your dosimeter parameters for your noise studies.

- ⊙ Customize measurement setup (i.e., criterion level, threshold, weighting, exchange rate, etc.)
 - ❖ See [Chapter 2](#) for getting started with your dosimeter
 - ❖ See [Chapter 3](#) for customizing your set-up parameters
 - ❖ See [Chapter 5](#) for Noise study scenarios



3. Running your studies.

- ⊙ Calibrate dosimeter
- ⊙ Attach the dosimeter
- ⊙ Run, observe, and stop your studies
- ⊙ Understand display indicators
 - ❖ See [Chapter 4](#) “Running and operating the Edge”



4. View your results via DMS.

- ⊙ Working with Charts and Graphs
- ⊙ Organizing and saving your studies
 - ❖ See [Chapter 5](#) to view measurements with Detection Management Software DMS



5. Develop corrective actions.

- ⊙ Engineering: redesign tools, implement changes in workstation
- ⊙ Administrative: job sharing/rotations, redefinition of job functions, reduce duration operating tool/equipment, and/or implement medical surveillance

The Edge Model

The “EG-4P” model features two virtual dosimeters with data logging. Once the parameters are set and saved in the dosimeter, you can monitor two different dosimeters by a single press of the **Enter** key. This will toggle you between the two dosimeters.

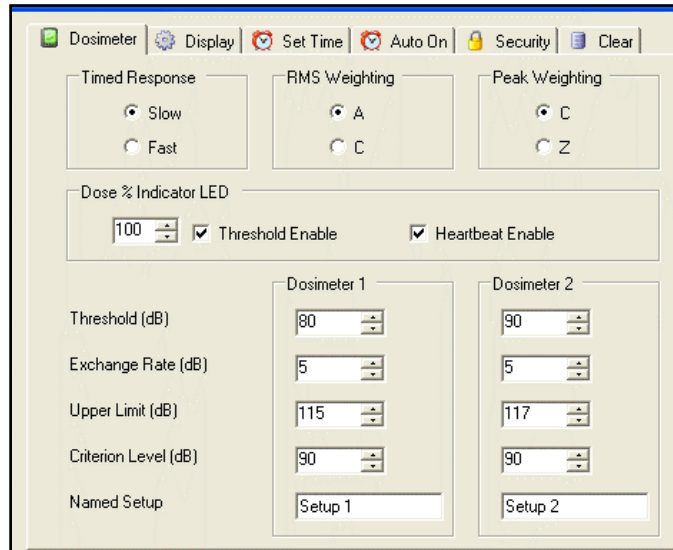

Figure 1-3
Parameter Setup Screen for EG-4P

Virtual Dosimeters

You can monitor and log noise studies by enabling two different parameter settings in one dosimeter, also referred to as “virtual dosimeters”. For instance, you may want to set one dosimeter to log using the OSHA HC (Occupational Safety and Health Administration - Hearing Conversation) parameters and also monitor noise with the OSHA PEL (Occupational Safety and Health Administration – Permissible Exposure Level) settings.

A few scenarios of virtual dosimeters include:

- Industrial noise control
- Hearing conservation compliance
- Work site assessments
- Personal noise verification
- Military applications
- Regulatory compliance (i.e., OSHA, MSHA, IEC, ACGIH)

CHAPTER 2

Getting Started

This chapter is designed to guide you through basic information to begin logging your studies.

Checking the Equipment

If your instrument was sent to you in a storage case, you will want to remove all the packaging and acquaint yourself with the following equipment so you can quickly get started with your noise studies.

NOTE

Depending on the accessories you selected, the dosimeter may have the following components. For the docking stations, you will either have an EdgeDock1 or an EdgeDock5. (For more information on parts/accessories, please refer to <https://www.tsi.com/>.)









Picture	Description	Picture	Description
	Edge Model EG-4P <ul style="list-style-type: none"> • Microphone and windscreen attached • Mounting clasps attached 		EdgeDock1
	DMS software Optional feature		EdgeDock5
	Extra windscreen for microphone		**Universal charger adapter (Power supply cord for the docking station)
	USB cable—connects EdgeDock to the PC		

Figure 2-1
Identifying your Equipment

Turning On

1. To turn on the Edge, press the **on/off** and **enter**  button.
 - ☑ The Edge **splash screen** (see Figure 2-3 for an example) will appear indicating the model (i.e. "EG-4P") and firmware version. The screen will be in the **measurement view**.

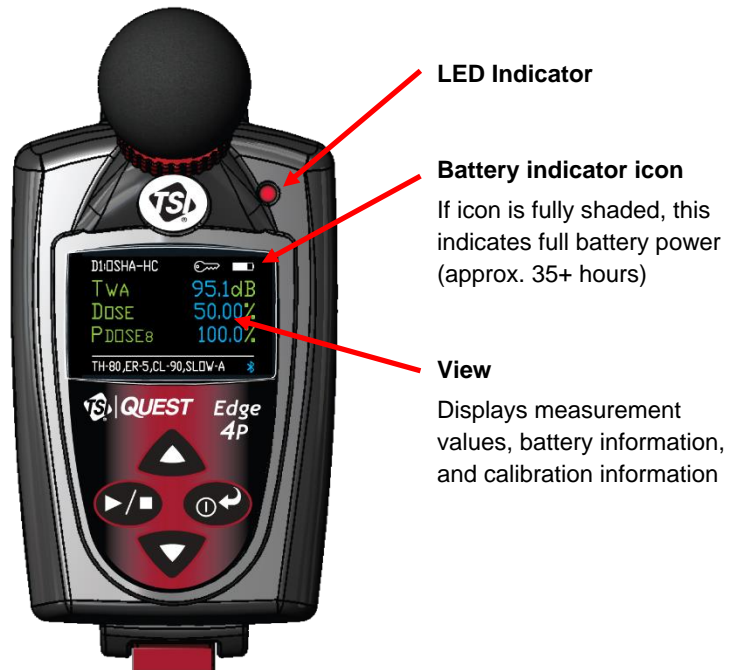

Figure 2-2
Powered on with Measurement View Displayed

LED Indicator

There is a three-color LED indicator on the Edge, located to the right of the TSI logo which includes Red, Amber, and Green.



Table 2-1 identifies when and why the LED indicator color will appear.

NOTE
The LED indicator can be disabled via DMS (see section, " Dose indicator LED ").



Figure 2-3
LED Indicator

Table 2-1
LED Indicators Explained

LED indicator	Explanation
 Red	A flashing red LED indicates the dose has exceeded the alarm level.
 Amber	A flashing amber LED indicates the dosimeter is stopped and has not exceeded the dose alarm level.
 Green	A flashing green LED indicates the dosimeter is running and has not exceeded the dose alarm level.

Navigating

Once the dosimeter is "Powered-On", press the **up/down ▲/▼** arrows to navigate through the measurement values and battery run time.

Turning Off

1. Press and hold the **on/off and enter**  button.
 - ☑ “3, 2, and 1” countdown will appear as the dosimeter is powered off.

NOTE

To halt the power off mode, let go of the **on/off enter** button.

Display and Keypad

The keypad is used to run and stop your studies, view your measurement values, and power on and off the dosimeter.

Diagram

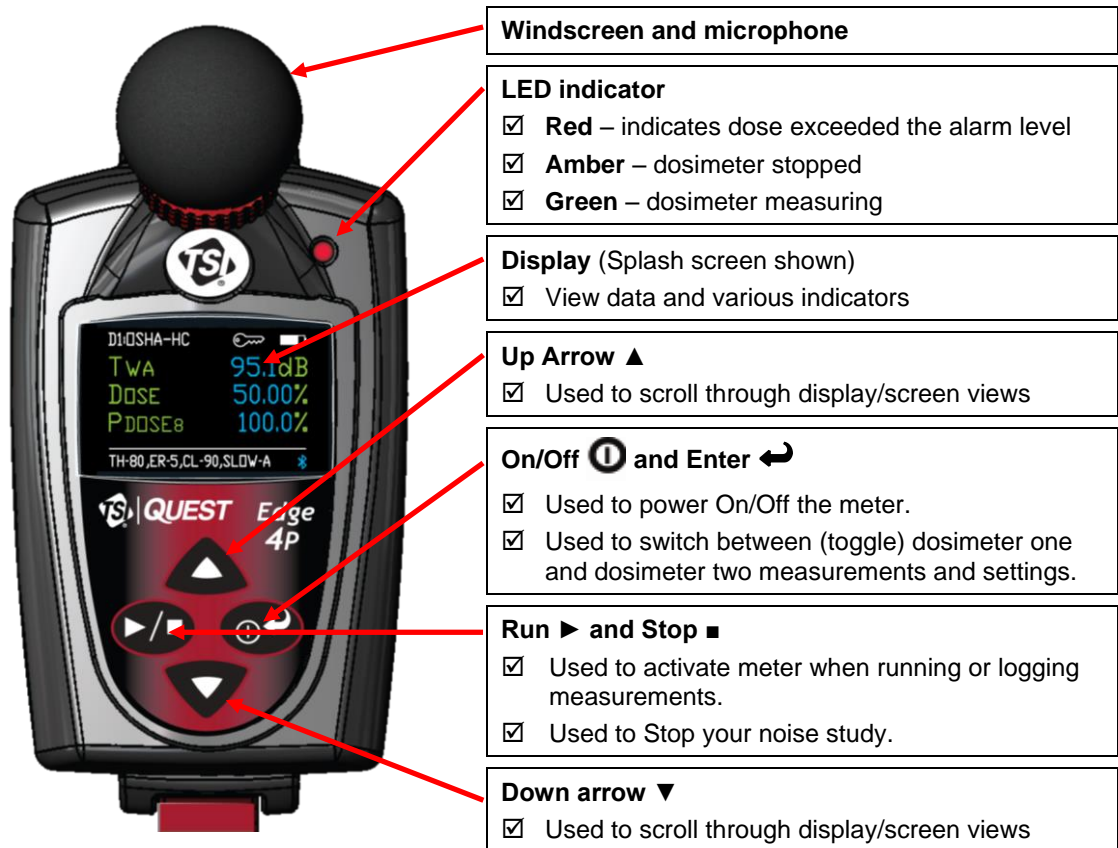

Figure 2-4
Edge Keypad

TSI Detection Management Software

TSI Detection Management Software (DMS) is a software application designed by TSI that runs under the Windows® operating system. You can use DMS for a variety of functions related to the Edge dosimeter and with many other TSI/Quest instruments. DMS has the ability to customize your set-up parameters, display data, manipulate data, and create reports.

Loading

To load DMS, follow the screen prompts.

The software will automatically load the drivers for the EdgeDock1 and/or EdgeDock5. If loading from the TSI Detection Internet site, follow the directions online located at www.tsi.com.

Docking Station Functionality

Depending on the kit you purchased, you may have an EdgeDock1 and/or an EdgeDock5. Both are designed similarly with the same LED indicators. The main difference with the EdgeDock5 is that it has five bays for docking, charging, and/or managing the dosimeters. If desired, the EdgeDock5 will charge all docked instruments at one time.

The docking station serves a **dual-purpose role**:

1. It is used to charge the battery on the dosimeter(s).
2. It is used to communicate between the software (DMS) and the dosimeter (i.e., import, export settings and measurement files).

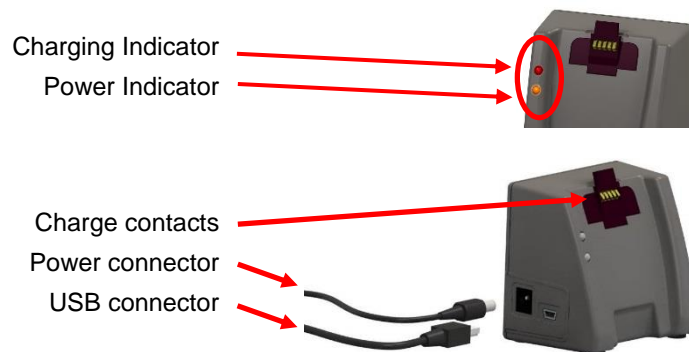

Figure 2-5
EdgeDock1

Docking Station Components

The table below explains the EdgeDock1 or EdgeDock5 LED indicators, power connector, USB connector, and contact pins.

Table 2-2
EdgeDock1 and EdgeDock5 components

Docking station components	Explanation
Charging indicator	Identifies if the dosimeter is “charging” or “fully charged”. A red blinking LED indicates the dosimeter is charging. A solid green LED equates to a fully charged dosimeter. (Note the charging indicator is the first, or top, LED indicator.)
Power indicator	An amber LED indicates the docking station is powered on.
Power connector	Attach the power connector cable to the docking station in order to charge the dosimeter(s).
USB connector	Attach the USB connector to communicate with the dosimeter(s).
Charge Contacts	Placing the dosimeter (s) onto the charge contacts allows charging and communication.

EdgeDock1 or EdgeDock5

The EdgeDock1 and EdgeDock5 are powered by a 12-volt charger adapter.

Figure 2-6 illustrates the assembly of the charger adapter and the plug adapter. It slides into place by guiding it down the back cavity (opening) of the power supply.

NOTE

The example is a typical adapter which may be different than the one you are using. Mechanically, it will function similarly.

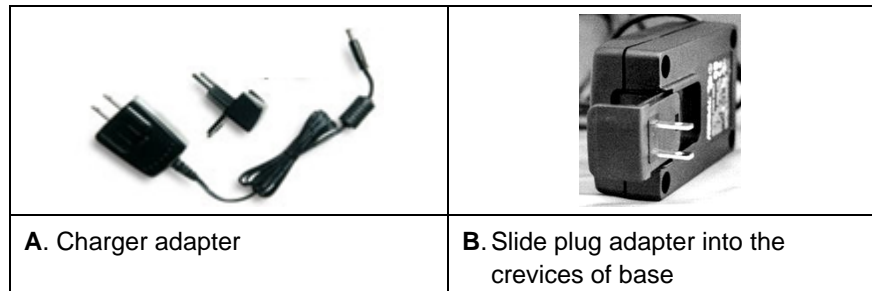

Figure 2-6
Attaching the Charger Adapter with the Plug Adapter

Powering EdgeDock1 or EdgeDock5

➤ Powering EdgeDock1 or EdgeDock5

1. Assemble the charger adapter and plug adapter as illustrated in Figure 2-6. (It will be the same process for an EdgeDock5.)
2. Plug the charger adapter directly into the wall (electrical wall plate).
3. Plug the opposite end into the power connector (or jack) of the EdgeDock1.

NOTE

An amber, solid light will appear indicating power to the charger.

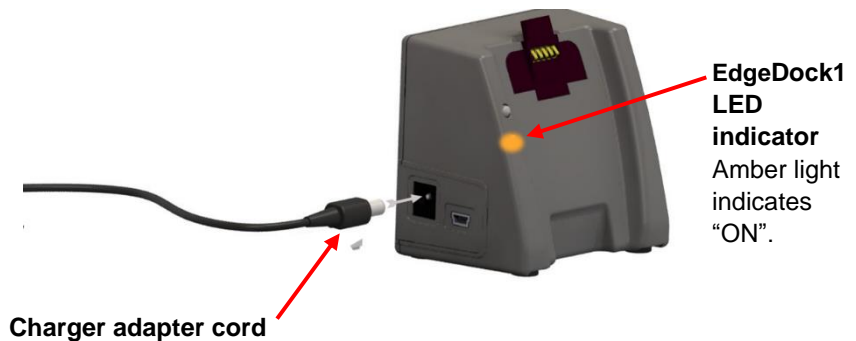

Figure 2-7
Attaching charger adapter to EdgeDock1 and EdgeDock5

Charging your Dosimeter

The number of hours you have used your dosimeter from your last charge will impact your total charge time. For example, if the battery clock indicator (see [“Checking the battery power”](#) for more information) displays 20 hours remaining on the battery and you want to charge the battery, the approximate charging time is 2 hours.

To charge a fully discharged battery, allow approximately 4 to 4.5 hours of charge time.

➤ How to Charge

1. Plug in the power adapter to the EdgeDock (see Figure 2-7).
 - When powered on, the EdgeDock bottom LED indicator will appear solid **amber**.
2. Slide the Edge (1) downward onto the **Hook** of the EdgeDock (see Figure 2-8 below).

NOTE

When the dosimeter is docked, the top LED indicator on the base will be illuminated. A **red** flashing LED indicates it is charging. A **green** solid LED indicates a fully charged battery.

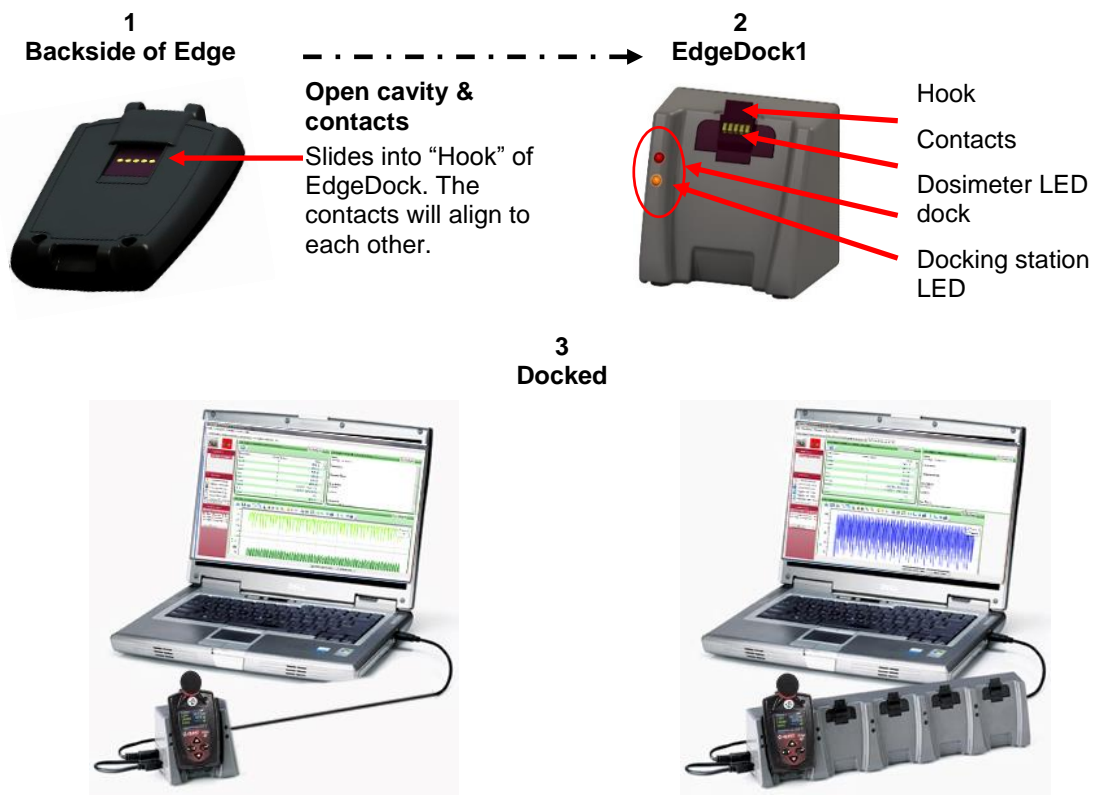

Figure 2-8
Docking the Edge with a Single and 5-bay Docks

Mounting the Docking Station to a Wall

The docking station is equipped with two single screw slots in case you wish to mount the docking station to the wall. The figure below displays the backside of the single bay dock.

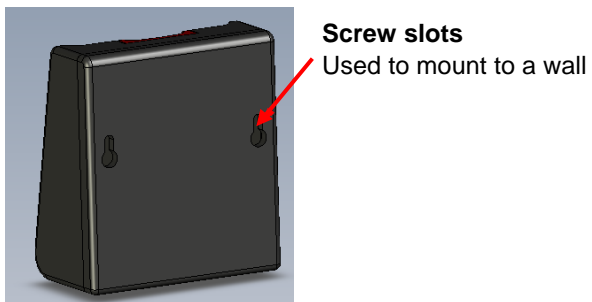

Figure 2-9
Backside of EdgeDock1

Storing the Dosimeter

The best place to keep the dosimeter is on a powered ON docking station. You may safely leave it docked there indefinitely. You may disconnect the computer USB cable to move your laptop or computer any time you are not using the DMS software.

Additionally, if the dosimeter is docked and stored on the docking station when the docking station is powered off, it will still draw a small amount of battery power from the dosimeter. In this condition, it is recommended to store the dosimeter(s) separately from the docking station.

To preserve the life of the battery, it is suggested that the dosimeter is turned off when you are storing the dosimeter in a carry case or other storage place.

(This page intentionally left blank)

CHAPTER 3

Setting up the Edge via Detection Management Software

Noise Studies

The EG-4P model comes equipped with two customizable user setups. You have the option to customize the parameters for threshold values, exchange rate values, an upper limit value, and a criterion level.

This chapter explains data storage, the pre-set views on the dosimeter, and how to customize the parameters and display of your Edge via Detection Management Software (DMS). It concludes with an explanation of downloading data from the dosimeter to the software.



Family:
Noise Dosimeters

Edge model

Download panel

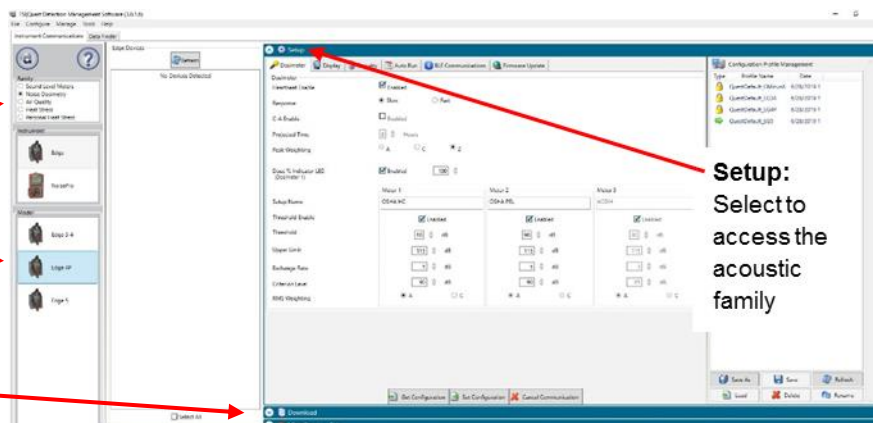

Figure 3-1

Edge Setup and Retrieve Data Buttons in Detection Management Software

Understanding What Data is Stored

When you are running noise dosimetry studies, there are two types of data stored on the dosimeter which include the summary data and time history (or Logged) data.

Summary Data

Summary data represents values that occurred over the entire run of the study. For an average value, such as Lavg, it represents the average decibel value over the entire run time. Peak and Max values are the highest measurements that occurred throughout the run time.



Description	Meter/Sensor	Value
Lasmn	1	59.7 dB
Lasmx	1	105 dB
Lavg	1	99.8 dB
Lcpk	1	122.1 dB
Mntime	1	1/18/2011 5:24:11 PM
Mxtime	1	1/18/2011 10:33:10 PM
OL%	1	0 %
Pdose	1	390.1 %
PKtime	1	1/18/2011 11:51:02 PM
Projected TWA	1	99.8 dB
Rtime	1	08:00:00
SEL	1	173.8 dB
TWA	1	99.8 dB
UR%	1	0 %

Figure 3-2
Sample Summary Data from Data Management Software Reporting

Time History

Time history data is also referred as “logged data” which plots measurement values in minute by minute intervals.

Time History data represents values that occurred over the most recent time period, which is the logging interval. For example, if the log interval is 1 minute, then the Peak value is the highest Peak value for that 1 minute, and the Lavg value is the average dB value for that 1 minute.

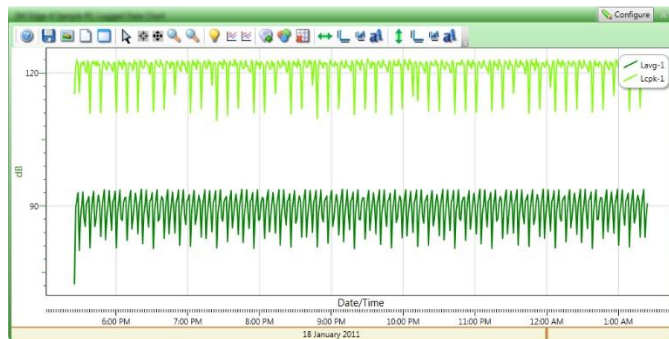
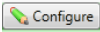

Figure 3-3
Sample Time History Data (or logged data) Chart

Logging

EG-4P model only logs at one minute intervals and includes the following measurements:

- Meter 1 logs Lavg/Leq, Lcpk, and LASMX
- Meter 2 logs Lavg/Leq

If the dosimeter runs for one hour, then it will log 60 Lavg/Leq results, and 60 LASMAX/Lcpk levels. In DMS, you can customize the logged data chart results by checking Lavg/Leq, Lcpk, and/or LASMAX measurement values when using the  button.

Views on the Edge

The Edge is a user-friendly and customizable dosimeter. In DMS, you may select the appropriate measurement values or views to appear or not appear on the display of your dosimeter using the Display Setup configuration as displayed below. Table 3-1 briefly identifies the displayed data values and views with a brief definition. (See the [glossary](#) for additional information of these terms.)

NOTE

The measurements/parameters are viewable in charts and graphs in DMS when downloaded.

Edge: customize what appears on the display

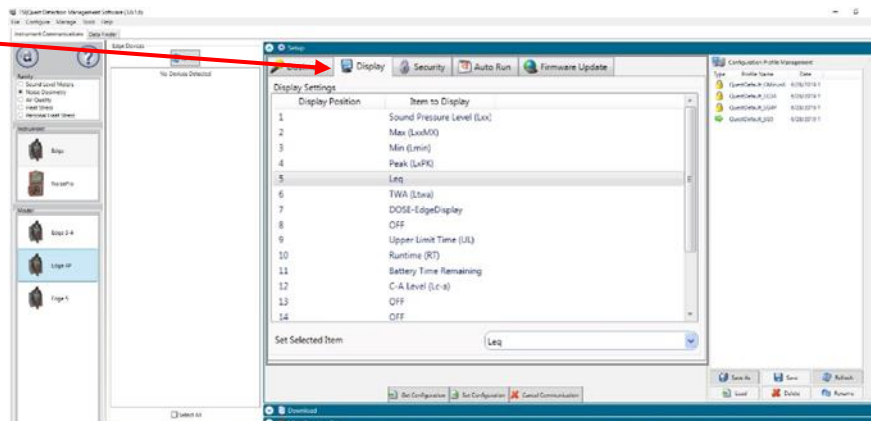

Measurements/parameters which appear on the Edge

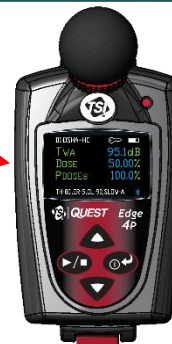

Figure 3-4
Customizing Display View

Definitions of Data Log Values and Views

To set up the Edge and work with noise-level data, you will want to have a good understanding of the terms listed in Table 3-1.



NOTE

The following table is based on **A**-weighted, slow measurements. Thus, if you choose **A** or **C**-weighted with Fast or Slow response the measurement values will change on the display (i.e., you selected sound pressure level with **C**-weighting with Fast response, it will display as LCF.) For further details, please see "[Edge Measurement Descriptors/Variants](#)" in Table 3-2.

Table 3-1
Dosimeter Views and Definitions

Views on the EDGE	Explanation
L _{AS}	Sound pressure level —is the basic measure of noise loudness, expressed in decibels. (In DMS this is noted as "SPL")
L _{ASMX}	Maximum sound level —is the highest sound level recorded during a measurement interval with a particular response setting (Slow or Fast) and weighting (A or C). L _{MAX} is the highest value that is included in Lavg or dose calculations. <ul style="list-style-type: none"> Under OSHA regulations, unprotected workers may not be exposed to maximum sound levels greater than 115 dB, measured with a Slow response rate.
L _{cpk}	Peak Level —is the highest instantaneous sound pressure level recorded during a measurement interval. Unlike the maximum level, the peak is detected independently of dosimeter settings for response rate or weighting. <ul style="list-style-type: none"> Under OSHA regulations, unprotected workers may not be exposed to peak sound levels greater than 140 dB.
L _{ASMN}	Minimum sound level —The lowest sampled sound level during the measurement interval allowing for the unit's Response Time setting (Fast or Slow).
L _{avg}	Average sound level — (in dB) computed for a chosen time duration, based on a 4, 5, or 6 dB exchange rate. Lavg with a 3 dB exchange rate is referred to as Leq (equivalent sound level). All sound levels at or above the threshold level are averaged into the calculations relating to noise exposure. Lavg is typically calculated with no threshold, with a threshold of 80 dB or with a threshold of 90 dB.

Views on the EDGE	Explanation
L_{TWA}	<p>Time-weighted average—is the sound level (in dB) that is accumulated for any time period but with its average level computed over an 8-hour period. TWA is usually measured with A-weighting, Slow response, and a 5 dB exchange rate.</p> <ul style="list-style-type: none"> All sound levels at or above the threshold level (cutoff level) are averaged into the calculations relating to noise exposure. TWA is calculated with no cutoff, with cutoff 1 (typically 80 dB), or with cutoff 2 (typically 90 dB). If the time period is less than 8 hours, the TWA will be less than the Lavg/Leq. If the time period is more than 8 hours, the TWA will be more than the Lavg/Leq.
L_{AE}	<p>Sound Exposure Level (SEL)—The sound exposure level averages the sampled sound over a one second period. Assuming the sampled run time to be greater than one second, SEL is the equivalent one-second noise that would be equal in energy to the noise that was sampled. SEL is typically measured using a 3 dB exchange rate without a threshold. (L_{AE} is not used by OSHA.)</p>
Dose	<p>Dose—Related to the Criterion Level, a dose reading of 100% is the maximum allowable exposure to accumulated noise. For OSHA, 100% dose occurs for an average sound level of 90 dB over an 8 hour period (or any equivalent exposure). (Please see Glossary of Terms for more details).</p>
UL	<p>Upper Limit—is the amount of time that the sound level exceeds a preset level (the Upper Limit).</p>
Response Level (Fast, Slow)	<p>Typically, noise is not constant. Using a response of Slow or Fast simply flattens the noise fluctuation and makes the sound level easier to work with.</p> <p>Slow: 1 second (1,000 milliseconds, or msec) Fast: 0.125 second (125 milliseconds)</p>
RT	<p>Run Time—The overall time of your noise study.</p>
Weighting (A, C)	<p>A and C weighting are types of frequency filters that cover the frequency range of human hearing (20Hz to 20 kHz).</p> <ul style="list-style-type: none"> “A” weighting: The “A” weighted filter attempts to make the dosimeter respond closer to the way the human ear hears. It attenuates the frequencies below several hundred hertz as well as the high frequencies above six thousand hertz. “A” weighted measurements are often reported as dBA. “C” weighting: provides a fairly flat frequency response with only slight attenuation of the very high and very low frequencies. “C” weighting is intended to represent how the ear perceives sound at high decibel levels and is often used as a “flat” response when LINEAR is not available. “C” weighted measurements are often reported as dBC.

Views on the EDGE	Explanation
	<p>Memory storage symbol—</p> <p>EG-4P: The EG-4P model displays the total memory storage remaining in hours and minutes. For example, if it displays the memory symbol 181:50 this represents 181 hours and 50 minutes of memory storage remaining on the dosimeter.</p>
	<p>Calendar symbol—The calendar symbol and calendar field displays the day-month-year</p>
	<p>Battery power clock symbol—The battery power clock symbol identifies the number of hours and minutes of battery time remaining on the dosimeter.</p>

Edge Measurement Descriptors/Variants

The following is an explanation of the Edge descriptors and equivalents for L_{MAX} , L_{min} , & L_{pk} .

Table 3-2
Dosimeter Measurement Descriptors/Variants

Descriptors	Variants
L_{max} variants	<p>Sound pressure level—is the basic measure of noise loudness, expressed in decibels. (In DMS this is noted as “SPL”)</p>
L_{ASMX}	<p>Maximum sound level—is the highest sound level recorded during a measurement interval with a particular response setting (Slow or Fast) and weighting (A or C). L_{MAX} is the highest value that is included in L_{avg} or dose calculations.</p> <ul style="list-style-type: none"> Under OSHA regulations, unprotected workers may not be exposed to maximum sound levels greater than 115 dB, measured with a Slow response rate.
L_{cpk}	<p>Peak Level—is the highest instantaneous sound pressure level recorded during a measurement interval. Unlike the maximum level, the peak is detected independently of dosimeter settings for response rate or weighting.</p> <ul style="list-style-type: none"> Under OSHA regulations, unprotected workers may not be exposed to peak sound levels greater than 140 dB.
L_{ASMN}	<p>Minimum sound level—The lowest sampled sound level during the measurement interval allowing for the unit’s Response Time setting (Fast or Slow).</p>

Docking

Communicating and Downloading Data

By using your docking station, USB cable, software, and your dosimeter, you can quickly communicate between the software and the dosimeter. There are two methods for communicating which are:

- **Send setup data:** Enables you to configure your set-up parameters in TSI Detection Management Software and download these parameters to the Edge.
- **Retrieve data:** You have the capability to retrieve the data from the dosimeter into DMS in order to view and analyze your studies in DMS' charts, graphs, and reporting functionality.

➤ How to Connect your Dosimeter to the Computer

1. Dock the dosimeter on the EdgeDock1 (or 5) and turn on the dosimeter by pressing the  button.
2. Plug the USB cable into the computer. (See “A” in Figure 3-4).
3. Plug the opposite end into the docking station (See “B” and “C”).

NOTE

The docking station will be powered through the computer; thus, it is not required to attach the charger adapter. To charge the dosimeter, plug in the charger adapter. (See “[Charging your Dosimeter](#)” for more information.)

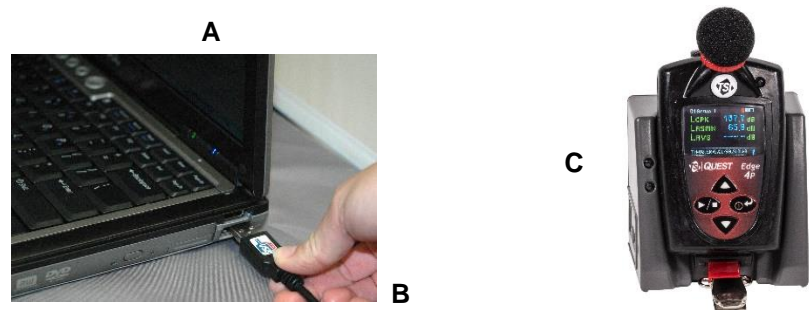

Figure 3-5
Communicating—Connecting a Docked Edge to a PC

4. For first time use of a docking station, **Welcome to the found new hardware wizard** will appear (see Figure 3-6). Select **No** and press **Next** through the remaining wizard. At the end of the wizard, press **Finish**.
 - **This will install the hardware components associated with your EdgeDock1 and/or EdgeDock5.**

NOTE

If you have more than one EdgeDock1 or EdgeDock5, this wizard will appear for each new dock which is connected to your PC.





Figure 3-6
New Hardware Wizard for Edge Dock

Customizing Set-Up Parameters in Detection Management Software

Customizing and saving setups are performed via Detection Management Software (DMS). The following sections discuss each of the setup screens and explain how to save and send the parameters to the dosimeter(s).

NOTE

The following DMS settings apply to the EG-4P model. If you are also using other models such as the EG-3/EG-4 and have them docked in a 5-bay charger, they will appear in the “Edge Bay Charger” tree section. If you are also using other models (EG-5) and have them docked in a 5-bay charger, they will appear in the “Edge Bay Charger” tree section with a  icon. To select Edge 5 models, first select the Model (on the left-hand panel) and then click the **Refresh**  button. The instruments are selected by clicking in the checkbox(es).

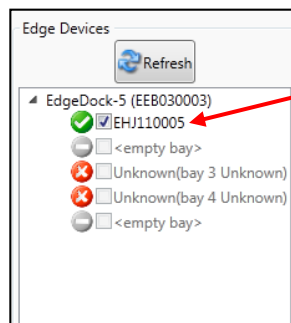

Example of EdgeDock-5 with Edge 4 selected in the first bay

Figure 3-7
Example of EdgeDock 5 with Edge 4 Selected

Dosimeter Setting

The Edge general settings are used to setup the instrument with basic parameters. The EG-4P model features two virtual dosimeters in one with two customized, user-defined settings. Refer to the Edge dosimeter settings table below for an explanation of setup details.

1. Click on the **Dosimeter** tab from the Edge’s Instrument Configuration panel (see **1**). To change the dosimeter settings, follow one (or all) of the selection options below.
 - Click on the checkbox to enable the dosimeter (LED) heartbeat, Dose indicator LED, and/or the Meter 1/Meter 2 Threshold settings.
 - Click in the circular button to select the response time (fast or slow), peak weighting (**C** or **Z**), and/or RMS Weighting (**A** or **C**).
 - To set the numeric fields either type in a value or use the  arrows to enter appropriate values for the Meter1/Meter 2 settings (threshold, upper limit, exchange rate, criterion level, and RMS weighting).

- When Meter 1 and Meter 2 settings are “enabled”, this will log (for EG-4P model only) two different setups simultaneously. Typically, users will set the meter 1 and meter 2 with different regulatory or local standards (such as EU directive and OSHA).
- To set the dosimeter settings, save and send to the Edge (for more details see “[Saving and Sending/Setting Configurations](#)”).



Dosimeter settings explained in the Edge dosimeter settings (below).

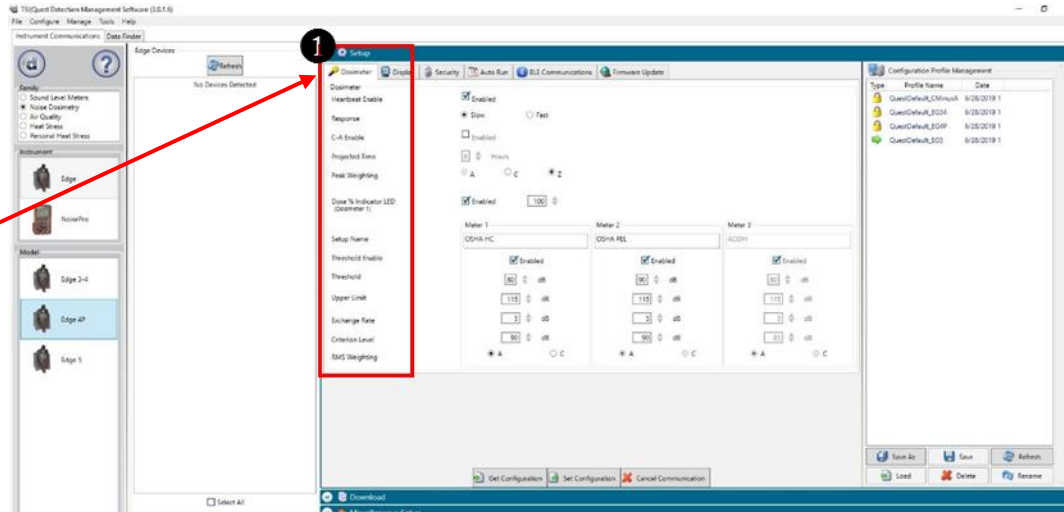

Figure 3-8
Dosimeter Screen

➤ Edge Dosimeter Settings

Table 3-3
Dosimeter fields explained for the Edge

Dosimeter settings for the Edge	Name Field *Note: Refer to Glossary for more detailed information.
Heartbeat enable	When enabled (or checked), the LED will flash green while running and flash amber when stopped.
Response	Either Slow Time Response or Fast Time Response is applied to the measurements. (Typically Slow time response is used in the US market while Fast is used in the EU communities.)
C-A enable	[EG-5 ONLY]: When enabled (or checked), C minus A will be calculated.
Projected Time	[EG-5 ONLY]: A selectable time parameter via the up/down arrows or type in a value. The projected time value is used to make projected dose calculation for the dose measurement. [EG-4/4P]: 8 Hours
Peak Weighting	Select either A , C or Z for the peak frequency weighting.
Dose indicator LED	When enabled (or checked), the LED will flash red when the dose value exceeds the designated entered value.

Dosimeter settings for the Edge	Name Field *Note: Refer to Glossary for more detailed information.
Setup name	(Optional field) A setup name may be entered into the Meter 1 and/or Meter 2 fields. When set, it appears on the top of Edge's display (example setup names: OSHA, MSHA, EU directive).
Threshold enable	When the checkbox is selected and a value is entered for meter 1 and/or meter 2, the threshold is used to calculate Lavg, TWA, and Dose measurements.
Upper Limit	Select a UL dB level by the up/down arrows or by typing in a value. (Note: The upper limit (UL) is a measurement setting in which the user selects a specific decibel level. The UL value records the amount of time that the Sound level is at or greater than the entered level.)
RMS Weighting	Select either A or C RMS Weighting. (Note: The RMS (root mean square) are the results from the Edge with the response time and weighting settings taken into account.)
Criterion Level	Select a Criterion level via the up/down arrow or by typing in a value. (NOTE: Criterion level is the average SPL that will result in 100% dose over the criterion time and is typically set by a regulatory agency such as OSHA, EU directive.)
Exchange Rate	Enter in (or select with up/down arrows) 3, 4, or 5 dB. ER refers to how sound energy is averaged over time. (OSHA uses a 5 dB doubling rate while most of the world uses 3 dB.)

Display Setting

The display screen is used to customize the parameters which will appear on your Edge. It is organized by two columns, the “**Display position**” and the “**Item to Display**” and includes a “**Set selected Items**” selection/drop down box. The display position indicates the order of the parameter (or item) which will appear on the display, while the “**Item to display**” designates the measurement or parameter. The example/figure below displays the SPL, Max, Min, Lavg, TWA, Dose, UL, RT, and battery time remaining parameters to appear on the display. (**NOTE:** There are up to 18 selectable parameters. Off indicates no item will appear.)

1. Click on the **Display** tab from the Edge's Instrument Configuration panel (see **1**). To customize the display, click on either the **Display position** (see **1**) or the **Item to Display** field (see **2**). The field will be shaded in blue when selected.
2. Click on the drop-down box of the **Set Selected Item** field (see **3**) and select a parameter (see **4**).
3. Repeat these steps as needed to select each position.

NOTE

“OFF” indicates that no item/parameter is selected.

- To set the display features (see 5), save and send to the Edge (for more details see [“Saving and Sending/Setting Configurations”](#) saving and sending configurations”).

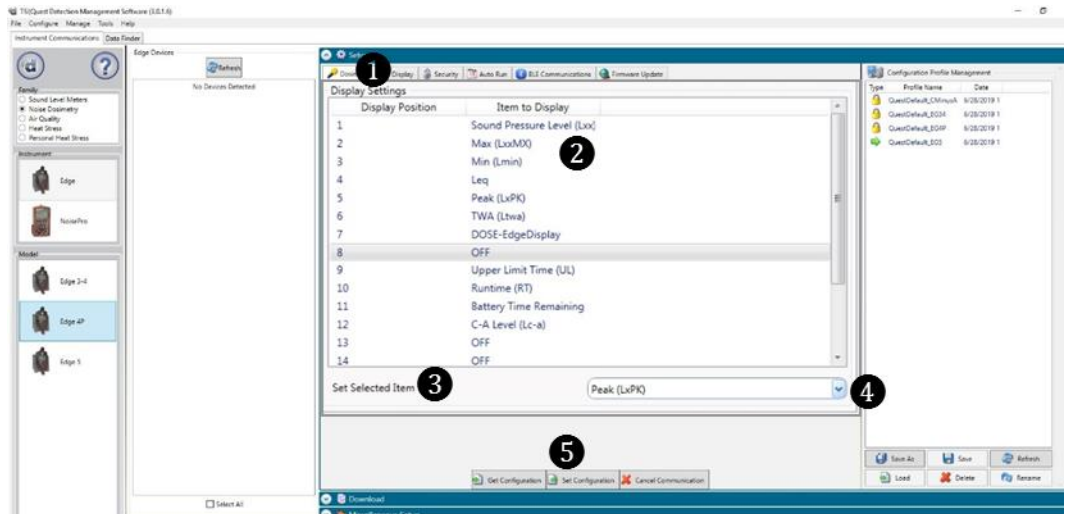

Figure 3-9
Edge Display Screen

Security Setting

The security setting is a type of “locking” feature (or secure run feature) that enables you to password protect the instrument to prevent users from inadvertently terminating a study. Initially, this feature is set through the software and turned on once in run mode by pressing **run/stop** key three consecutive times. (To unlock, press **run/stop** key three consecutive times and then press **power** key.) To set this feature, follow the steps below.

- Click on the **Security** tab from the Edge’s Instrument Configuration panel (see 1). To enable, click on the **Enabled** check box. (Ensure the specific Edge is selected and communicating to the software. See [“Communicating & Downloading Data”](#) for more information.)
- Next, select either **Not Displayed** (see 2) or **Displayed** (see 3) for the measurement visibility.

NOTE

If measurement visibility is set to “not displayed” then a padlock icon appears on the Edge display. If displayed is selected, the measurements appear with a small padlock in the header section of the display indicating the instrument cannot be stopped during a run while in secure run mode.

- Click the  **Set Configuration** button to set the security setting (for more details, see [“Saving and Sending/Setting Configurations”](#)).

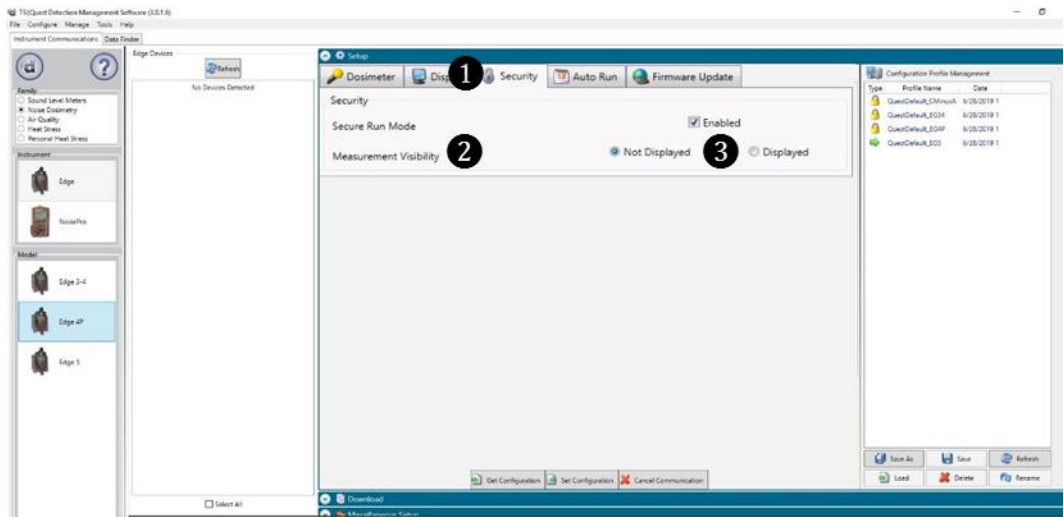



Figure 3-10
Edge Security Setting Screen

Auto Run Setting

With the Edge auto run setting, you may program up to two *auto start* and *auto stop* configurations when start date and duration parameters are enabled. This may be useful if you want to pre-set the instruments to run and stop for a specific time period, such as a week-long study. See steps below to enable.

1. Click on the **Auto Run** tab from the Edge's Instrument Configuration panel (see **1**) and click in the **Enable** auto run mode checkbox (see **2**).
2. To program **Date 1**, click in the **Enabled** checkbox and select a **Start Date** (by using the calendar icon or type in a date). Select the **Duration**, by either typing in the time (designated in hours, minutes, and seconds) or using the up/down arrows (see **3**). (Repeat this step to setup a second Auto run mode, except select **Date 2**. See **4**.)
3. Click the  **Set Configuration** button to set the auto run setting (for more details, see "[Saving and Sending/Setting Configurations](#)").

NOTE

On the Edge, Power Off the instrument when the configuration is set in order to auto-start the instrument.

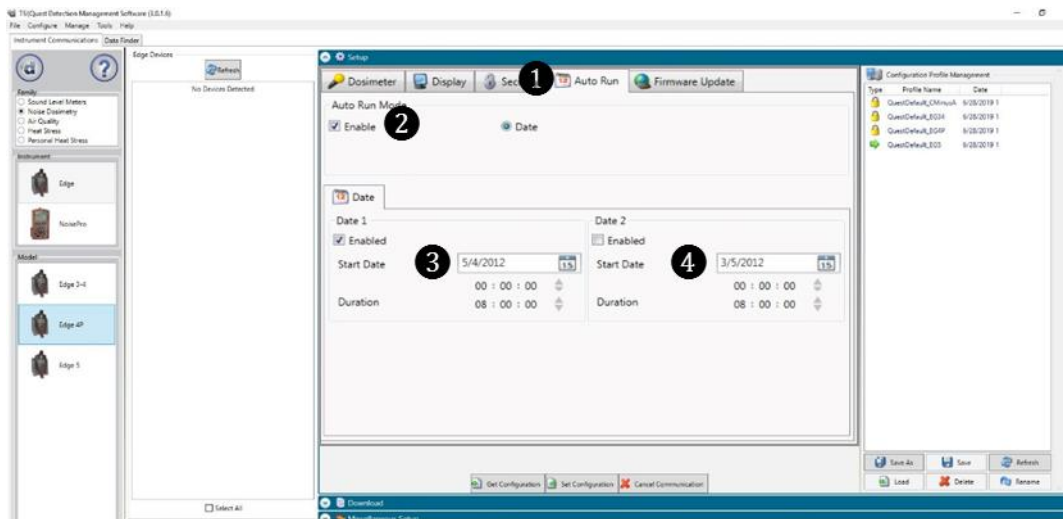



Figure 3-11
Edge Auto Run Screen

Firmware Update

Edge firmware updates are performed in DMS when the instruments are docked, communicating, and the update key is selected. Please follow the steps below prior to updating your Edge(s).

NOTE

This feature enables you to update all of your docked Edges (when powered on and not in run mode).

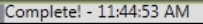
1. Click on the **Firmware** tab from the Instrument Configuration panel (see 1) and ensure to dock the Edge (or Edges). Please read steps under "[Firmware Update](#)" prior to updating (see 2).
 - Press  button to refresh the docked instruments (if necessary).
2. Press the  button and please wait until the software states that it is **Done**. (Example of the message,  See 3).

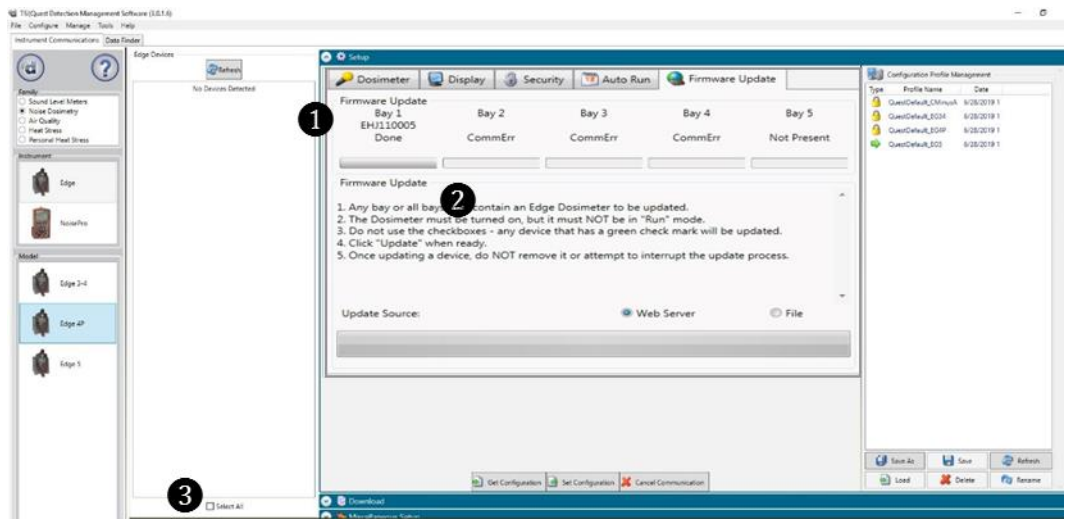

Figure 3-12
Edge Firmware Update Screen

Saving and Sending/Setting Configurations

With the Edge, there are saved setup profiles used to quickly access and apply to The Edge(s). Below explains how to save configuration settings in DMS and how to send/set to the instrument.



NOTE

If you want to only send the setup, skip to step 3. Refer to this section as you setup your instrument.

1. To save the Edge configuration in the software, click on a name in the **Configuration Profile Management** panel (See 1).





NOTE

The name will be shaded a light gray when selected.

- To create a new profile name, click  and type in a profile name. Click **Save**. (It will save under the configuration profile management panel).
2. Click on the  button (see 2) and type in a **Name**. Click **Ok**.

NOTE

This saves the configuration file in the software.

- Or click  button and rename the setting by typing in a name. Click **Ok**.
3. To send to the instrument, select the  (see 3).  

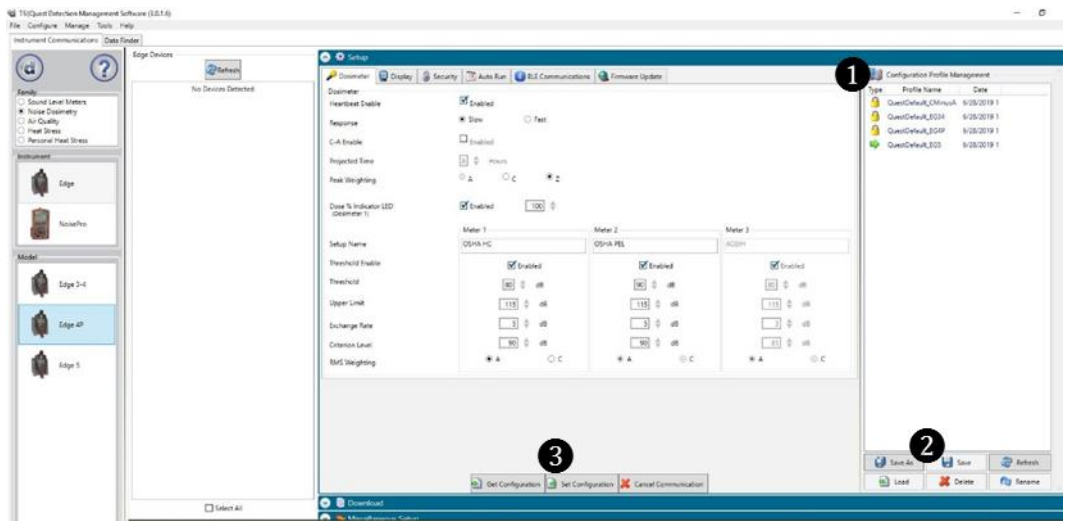

Figure 3-13
Saving and Sending Edge Setups Screen

CHAPTER 4

Running and Operating your Dosimeter

The focus of this chapter is to discuss the procedures for running and operating the Edge and includes positioning, calibrating, and viewing the Edge measurements.

Overview of Running a Study

The list below is a brief overview of the steps for running a study.

Quick Help List: Typical Dosimetry Session



1. Turn the dosimeter on and check your battery power.
2. Reset the dosimeter.
3. This will clear out all of the data history before your study begins to ensure you have sufficient memory space on the Edge.
4. Set-up your study parameters via DMS.
5. Calibrate the dosimeter.
6. Attach the dosimeter for your personal noise study.
7. Press the **Run/Stop**  button to start the study.
8. When you are ready to end your study, press the **Run/Stop**  button to stop the study.
9. Review your results either on the meter or download to DMS for further analysis (graphs/charts, saving and printing).

Figure 4-1
Quick Help List for Running a Study

Positioning the Edge on your Shirt

Depending on what accessories you ordered with the Edge, you may have either clips on the top and bottom of the dosimeter or some other type of mounting device. (Refer to Chapter 6, "[Technical Support](#)").

➤ How to Attach the Dosimeter

1. Clip the dosimeter on your shirt and ensure the microphone is positioned as high on your shoulder as possible and away from your neck.
 - a. If the noise seems to come from one direction, place it on the shoulder and near the noise source.
 - b. During monitoring, keep clothing from coming into contact with the windscreen to avoid contaminating your results.



Figure 4-2
Positioning/Attaching the Edge Dosimeter

Windscreen and Maintenance



Before measuring, ensure the windscreen is free from any accumulated dirt. If you ordered a kit (as explained in [Chapter 2](#)), there are replacement windscreens in the carrying case for your convenience. Please refer to Figure 6-1 for details on replacing the windscreen.

Checking Battery Power

Typically, the life of the battery is approximately 60+ hours (see [Appendix A](#) for specific specifications). The dosimeter can be charged at any time by using your EdgeDock.

There are two battery identifiers on the dosimeter which are the battery indicator icon and the battery power clock (see Figure 4-3).

➤ Checking Battery Power

1. The **battery indicator icon** (located at the top right of your screen) gives an approximation of battery life and is always present.
 - If the battery indicator is half shaded, this illustrates you have approximately 30 hours of battery life remaining.
 - If low battery appears, less than 8 hours of run time is available.
2. Additionally, there is a **battery time remaining measurement** which identifies the number of hours and minutes remaining on the dosimeter.
3. To view, press the up/down arrows ▲/▼. This will navigate your through the views of the dosimeter.

NOTE

The battery time remaining measurement can be disabled from the view of the meter. See [Chapter 3](#) for explanation on changing the display.



Battery indicator icon

When fully shaded, this indicates full battery life.

Battery time remaining

Figure 4-3
Battery indicators

Calibrating

TSI recommends you calibrate your dosimeter before you run your study(ies) and after your study(ies) to ensure highly accurate measurement results. The steps below address how to calibrate for either a pre or post calibration.

➤ Calibrating the Dosimeter

1. Remove the windscreen from the dosimeter by unscrewing it (see Figure 6-1).
2. Ensure the Edge is turned on and in the stop mode (see [“Turning on”](#) and [“Turning Off”](#)).
3. Slide the Edge microphone into the mouth of the calibrator.

NOTE

Ensure the adapter ring is inserted into the mouth of the calibrator before you slide the Edge into the cavity.

4. Turn on the calibrator and ensure parameters are set to 114 dB and 1000 Hz. (See calibration manual for operation details.)

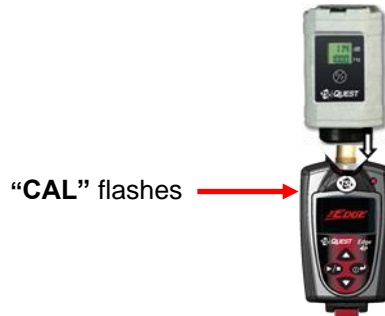





Figure 4-4
Calibrating

5. "CAL" will flash on the display when detected. If CAL does not display, you may activate Cal mode by depressing and holding the 2 buttons: **UP** and **DOWN** at the same time, for about 3 seconds.
6. Press the **on/off enter**  button to trigger the (field) calibration display.
7. To match the values on the calibration display, press repeatedly the **up** or **down** arrow in order to select the exact output on the calibrator (i.e., 114 dB).
8. When you have selected the appropriate dB level, press the **on/off enter**  button.
9. A shaded bar will appear loading your calibration information. Then a summary calibration screen will appear indicating the dB level with date and time displayed.
10. To return to the measurement view screen, press the **on/off enter** .
11. To end the calibration steps, turn off the calibrator. Detach the dosimeter from the calibrator.

Resetting the Dosimeter

The Edge can be reset through the dosimeter keypad or via Detection Management Software. The steps below outline how to reset your dosimeter.

➤ Reset





1. Ensure the meter is **Off**.
2. Turn the meter on by pressing the **on/off enter**  button.
3. When the splash screen appears, press and **hold** the **run/stop**  and **on/off enter**  buttons until the splash disappears.



Figure 4-5
Splash Screen

4. The **Setup menu** appears on the Edge. Press the **up** or **down arrow** to select the reset icon  (symbol).

NOTE

Setup menu is used to reset the dosimeter, change the contrast, and return to the main view.

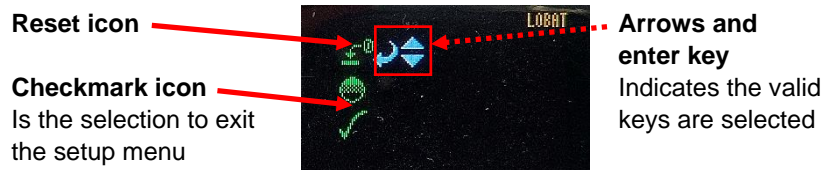







Figure 4-6
Resetting the Edge from the keypad

5. Press and hold the **on/off enter**  button.
6. A 3, 2, 1 countdown will appear, and then a shaded bar will appear indicating the dosimeter is being reset.
7. Press the **down arrow** until the checkmark icon is selected (denoted by the arrows). Then, press the **on/off enter**  button to return to the measurement view screen.

Setting Contrast on Dosimeter

➤ Contrast

1. Ensure the meter is **Off**.
2. Turn the meter on by pressing the **on/off/enter**  button.
3. When the splash screen appears, press and hold the **run/stop**  and **on/off enter**  buttons (see Figure 4-5 for splash screen).
4. The **Setup menu** appears on the Edge. Repeatedly press the **arrow key** until the Contrast symbol is selected.



NOTE

Setup menu is used to reset the dosimeter, change the contrast, and return to the main view.



Figure 4-7

Changing the Contrast from the Keypad



5. Next press the **on/off enter**  button.
6. A number will appear on your display (i.e., 50). Press the **up** or **down arrow** to increase or decrease the contrast of the Edge.
7. Press **on/off enter**  button to accept the new contrast value.
8. To return to the measurement view screen, press the **down arrow** and press the **on/off/enter**  button.

Running Studies

With a couple pushes on the keypad buttons, you will be running and viewing your study(ies). Following your study(ies), you can load the data/files into DMS to manipulate, analyze, save, and create reports (See [Chapter 5](#) for viewing your logged data in Detection Management Software).

Starting a Run

➤ How to Run a Noise Study

1. If your dosimeter is turned off, press the **on/off enter**  button to power on.
2. Press and hold the **run/stop**  button.
 - A 3, 2, 1 countdown will appear.
3. When running, the following will appear:
 - A run indicator will appear on the top-right side.
 - The LED indicator will flash green (unless you disabled this in DMS.)

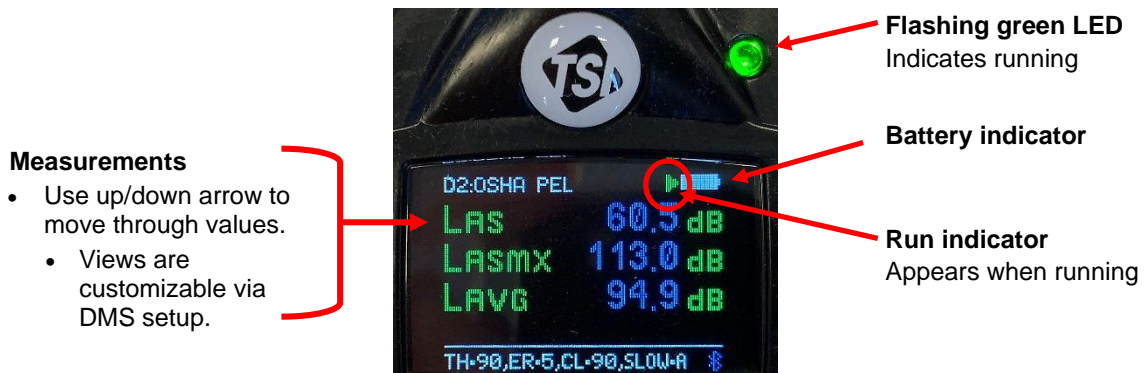



Figure 4-8
Display screen while running

Stopping a Study

While the dosimeter is running, you can end the study by pressing and holding the **stop** button.

➤ How to Stop a Noise Study

1. While **running**, press and hold the **run/stop**  button.
 - a. A 3, 2, 1 countdown will appear.
 - b. The stop indicator  will be shown in the display.

Indicators/Icons on the Display

The Edge is equipped to notify you of operational/status updates. These indicators (or alert notices) are located on the top right-hand side of the screen. Table 4-1 explains the function of each indicator.

Table 4-1
Indicators (i.e., run, stop, battery, and overload)

Indicator Icon	Explanation
■	Stop —indicates the dosimeter is currently in the stop status (opposed to run).
▶	Run —indicates the dosimeter is currently logging a study.
▬	Battery charge status —when completely shaded in black, this indicates full battery power. If half shaded, this represents ½ battery power
OL	Overload —will appear whenever the input signal exceeds the range of the dosimeter.

Viewing Measurements on the Display

The up/down arrows on the keypad of the dosimeter enable you to move through the various measurements. For specific information on the views of the Edge, please see "[Views on the Edge](#)".

➤ Viewing Measurements

1. Press the ▲ or ▼ arrow. This will move you through the views on the display.

NOTE

If you enabled only one measurement to appear on the display, when you press the up/down arrows it will not show any other measurement values. (To enable additional measurement settings, see the "[Edge Display Screen](#)".)





Figure 4-9
Measurement View on the Edge

Locking or Securing your Dosimeter During Run

As explained previously under DMS set-up parameters, the security or lock feature is designed to lock the meter during run to ensure the study will not be stopped unless the lock feature is disabled. (Setting this feature is programmed via DMS. See "[Security Setting](#)" for more details.)

Locking or Securing

➤ How to Lock or Secure

1. Turn the dosimeter on and press the **run/stop**  button to begin logging your study.
2. To enable the lock, press **run/stop**  button three consecutive times within one second intervals.
 - The Lock screen will appear.

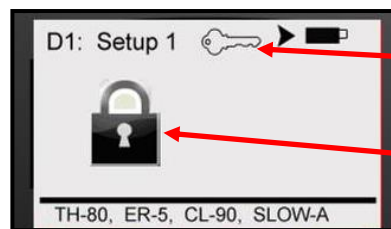

Key indicator

Indicates dosimeter is locked while running.

Padlock icon

Secure all



Figure 4-10
Locking/Securing run

NOTE

If lock/secure run does not activate, check that locking is set-up on your dosimeter.

Unlocking

➤ How to Unlock

1. To unlock, press **run/stop**  button three consecutive times, within one second intervals, and then press the **on/off enter**  button.
 - a. If the padlock icon and the key indicator were on the screen, these will vanish and the measurement view will appear along with the run indicator.
 - b. If you enabled the lock feature (with the key indicator showing and the measurement view showing), then the key indicator will disappear.
2. To stop your study, press the **on/off enter**  button and the 3, 2, 1 will display as it ends the study.
 - a. To download and view your results in DMS, see [Chapter 5](#).

(This page intentionally left blank)

CHAPTER 5

Viewing your Studies in Detection Management Software

The focus of this chapter is to discuss how to view your studies with the TSI Detection Management Software (DMS). The first section explains how to retrieve your studies from the dosimeter, and the subsequent sections will then walk you through viewing, organizing, and customizing your studies.

NOTE

You have the option of ten different languages in DMS including: Chinese (Simplified), English, French, German, Italian, Korean, Portuguese, Japanese, Russian, and Spanish.

Downloading Data

Loading your studies entails communicating, downloading the sessions/studies (files) and viewing the files in the data finder page, charts and graphs, and/or report views.

➤ Downloading

1. Ensure DMS is downloaded.
 - Install the software from the USB flash drive or visit our website at <https://www.tsi.com/>.
2. Dock the dosimeter(s) and connect it to your PC using the USB cable.



Figure 5-1
Communicating Between your PC and the Edge

- Power on the Edge by pressing the  button.

NOTE

The Edge will only download and communicate when stopped, as indicated by  icon on the top of the screen.

- In DMS software's start screen, choose .

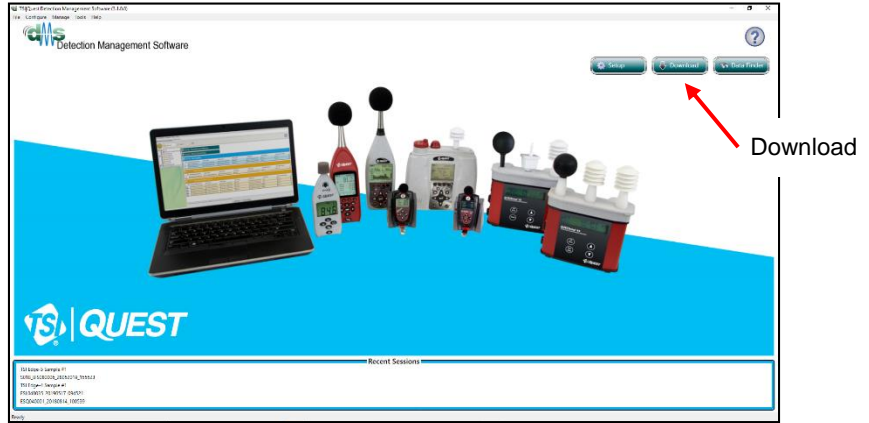

Figure 5-2
Detection Management Software Start Screen

- Select **Noise Dosimetry** (see 1), Edge (see 2), and Edge 4P (see 3) from the family panel.
- Select the docked Edge (s) to download by clicking in the checkboxes by the EdgeDock-1 section (see 4).

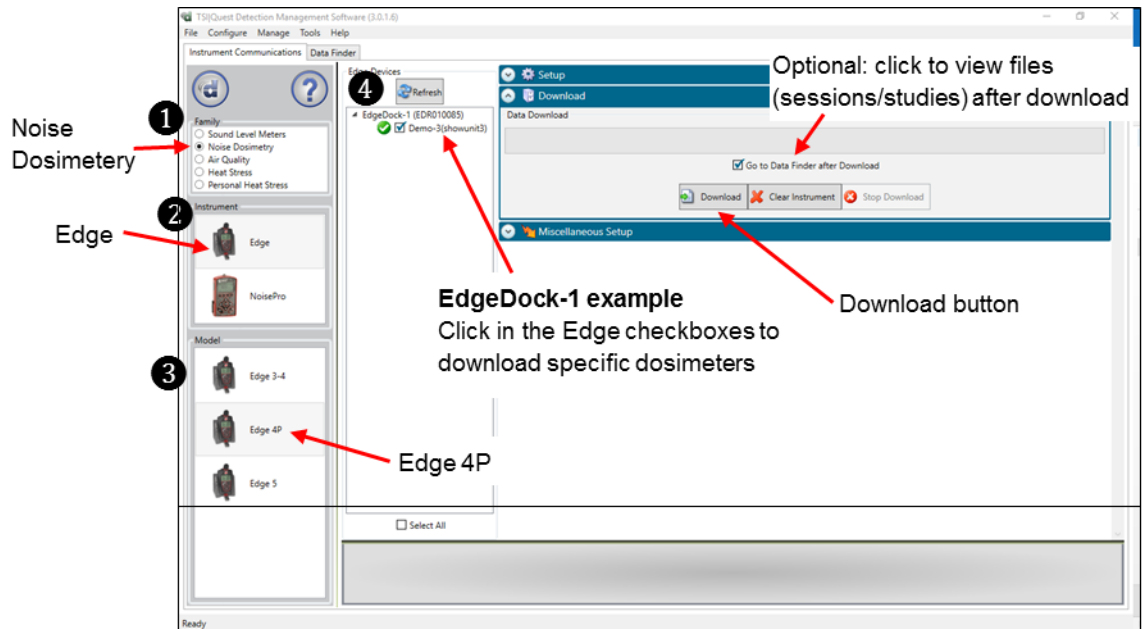





Figure 5-3
Downloading with the Edge Model EG-4P

7. Click  button.
 - In the status field, it will state download is successful.
 - Then, a clear the memory prompt will appear. Click **yes** to clear the memory or click **no** if you want to save the data on the dosimeter.
8. The **sessions** (files) will load and post to the Data Finder page under Family: Noise Dosimetry heading.
 - **Quick tip:** click on the  button and the data files will post directly under the specific family. Click on the file and select either   to view in charts and graphs.

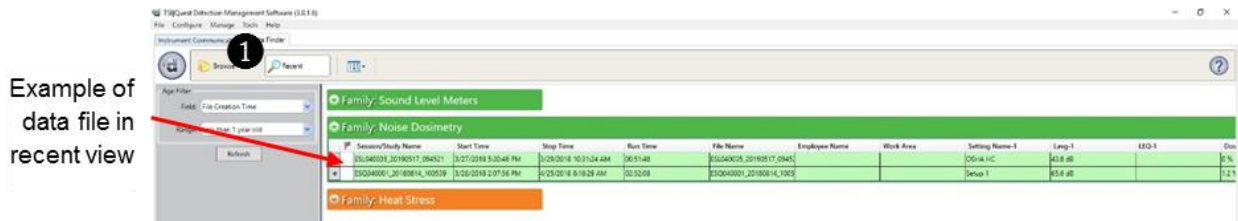

Figure 5-4
Recent Downloaded Data

Viewing Data and Data Finder Page

After the data is downloaded, it is stored and viewable in the data finder. With a quick double-click, the information is viewable in customizable graphs and/or charts.

➤ Selecting and Viewing Data

1. In the Data Find page (see 1), select the **Noise Dosimetry** data (see 2) by clicking on either the session/study



NOTE

You may need to expand to see the study data.

- Once selected, it will appear with a blue shading.
2. **Optional:** To reorganize the data displayed in the data finder columns, click drag and drop the titles of the columns in different positions. To shrink/expand the columns, click and drag the black column divider(s).

NOTE

These methods are similar to positioning/expanding in Microsoft® Excel® spreadsheet program.

3. To view in Graphs and Tables, click on  or  buttons.

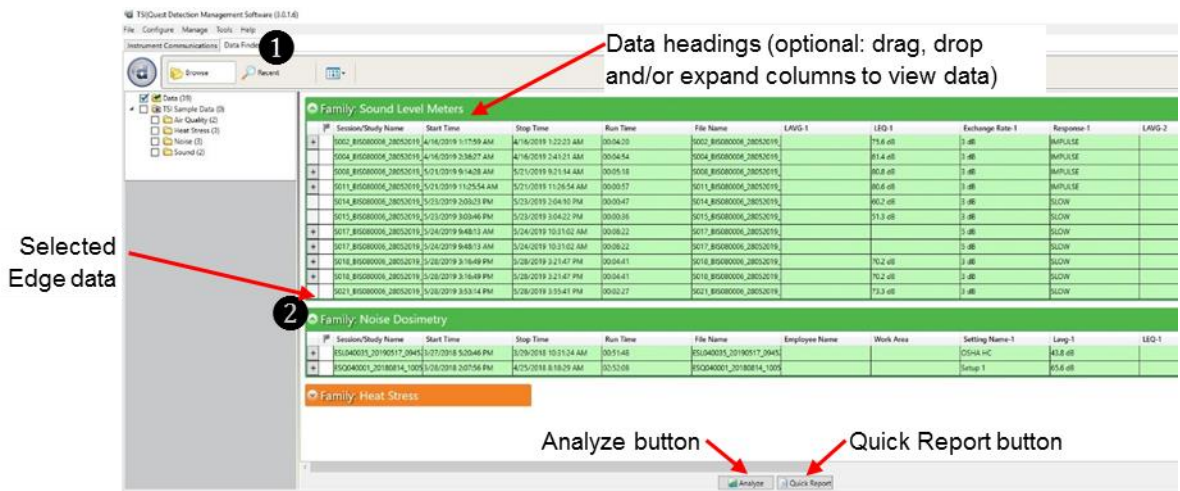

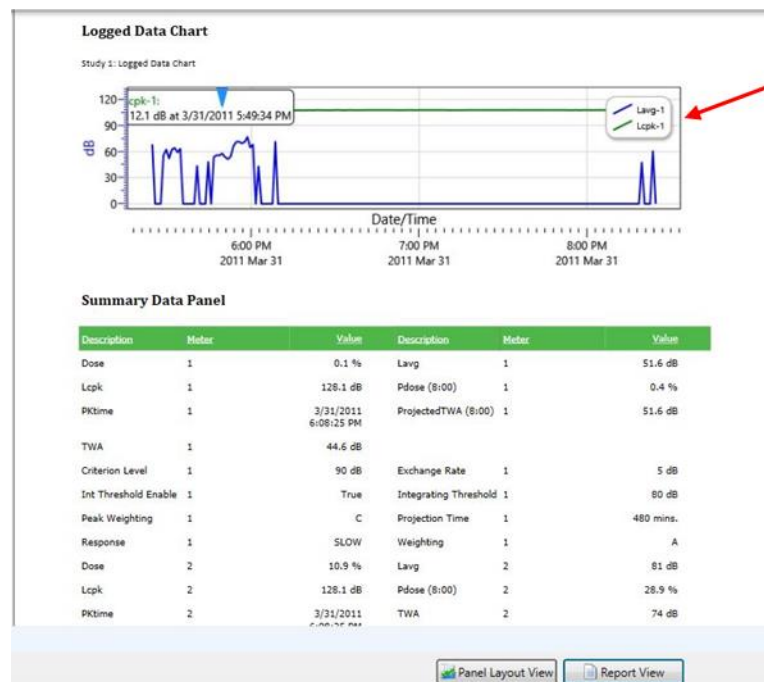

Figure 5-5
Data Finder Page with the Downloaded Data

Report View

The  button provides a quick link to view/print the Edge data. To customize the data, refer to the next session, panel view page.

- Click  to print the report.



Edge, logged data chart displayed in DMS report (scroll through to view the online report if applicable).

Figure 5-6
Example of Edge Report in Detection Management Software

Panel Layout View (charts/graphs)

Panel Layout View

Analyze

When you are in the data finder page (see above), select either the **Analyze** button or double-click on a session/study to view the data in charts and graphs as displayed in Figure 5-7. The measurements and parameters will be displayed in charts and graphs which may be customized for analysis and/or reporting purposes.

1. In the panel layout view page, it is divided into Work Items (see 1), Add panel (see 2), Arrange Panels (see 3) and data panels (see 4).

- **Work items (1)**—select either the session or study (in order to view appropriate measurement/parameter data).
- **Add panel (2)**—double-click on a chart/table type and it will appear as a panel on your screen.
- **Arrange panels (3)**—displays the order of the sessions/studies displayed in the panel section of your screen.
- **Data Panels (4)**—used to view your measurement and/or parameters from your study.

NOTE: Use the menu bar icons and/or configure icon to customize parameters.

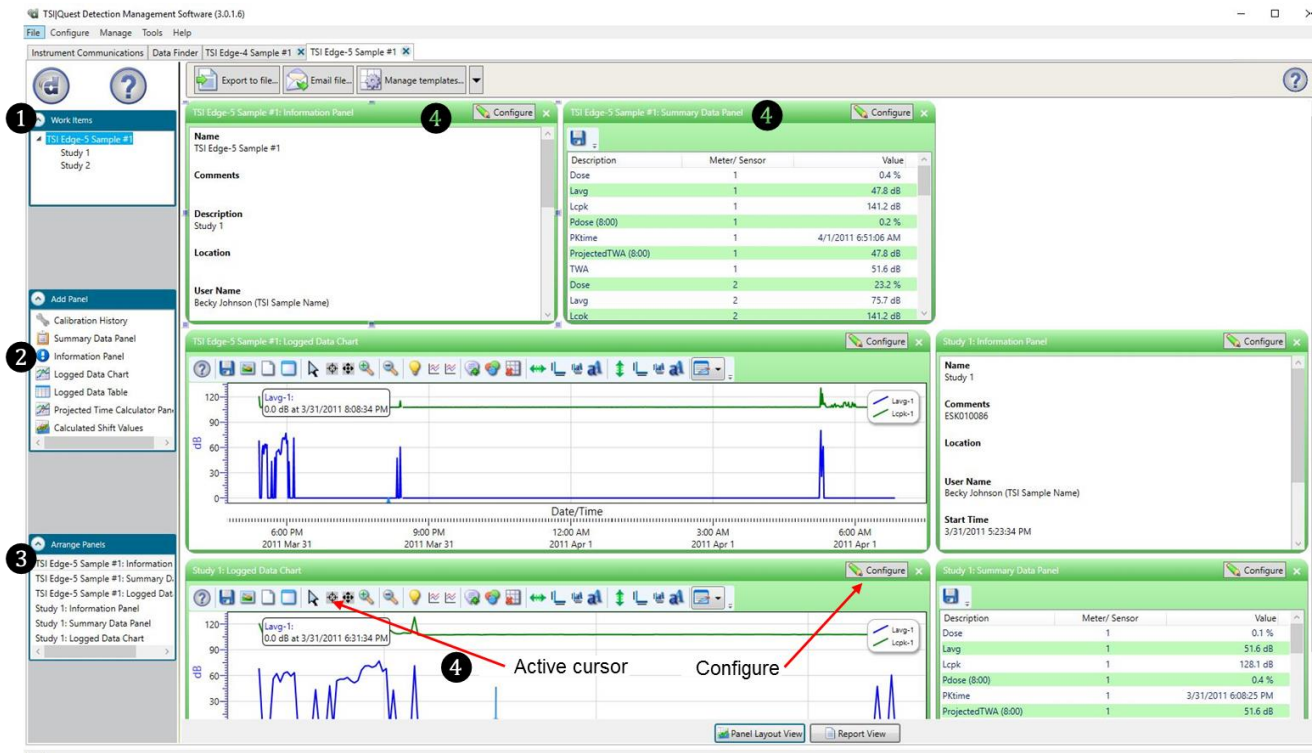







Figure 5-7
Panel Layout View (viewing the data in charts and graphs)

Quick Tips with Panels (charts/graphs)

- **To stretch the graph**, click on one the corner's edge of a chart or table and drag the mouse. The graph will expand and widen (depending on how you drag your mouse).
- **To move the graph**, click drag and drop to the appropriate panel position.
- **To change ranges**, when clicking on either the x-axis or y-axis, click and drag the mouse until the appropriate range is selected.

NOTE

It will span the numbers up or down depending on how you drag the mouse.

- **To add labels**, click on the add labels  icon. Right-click and select **edit text** to add note/label on the chart. Type in text and press the **Enter** key (on your keyboard). To move the label, left-click and hold to drag to appropriate location on graph.
- **To customize chart colors**, click on the  icon and using the properties box, select different colors as needed.
- **To customize x or y axis font type**, click on  or  icons.
- **To export data to .xls file**, click on the export  icon.
- **To save a layout**, right-click outside the tables/graphs area as displayed. Click **Remember Setting**.

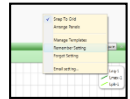

CHAPTER 6

Additional Product Support

LED Indicator: Disable/Enable

Follow the instructions below to turn off the LED indicator.

- ☑ To disable this feature, open DMS and select the **Setup** button. On the dosimeter tab, under **Dose% indicator LED** uncheck the following:

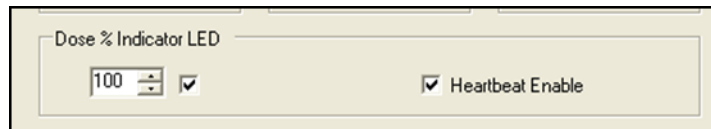

- ☑ **Alarm enable:** Will disable the flashing red LED when the threshold entered exceeds the designated value during run mode. (If checked, red LED will flash.)
- ☑ **Heartbeat enable:** Will disable the flashing green LED the dosimeter is running. (If checked, a green LED will not flash.)

NOTE

For more information, see section on [Dosimeter Settings](#).

Replacing Microphone and Windscreen

Attaching/Detaching

The Edge features a field replaceable microphone and a screw-on removable windscreen. TSI Incorporated suggests that you replace the windscreen whenever dirt has accumulated on the windscreen prior to measuring data.

NOTE

If you ordered an Edge kit, extra windscreen(s) will be included in your case.

➤ Attaching/Detaching the Windscreen and Microphone

1. First, unscrew the windscreen by turning the red ring (not the foam!) in a counterclockwise direction.

NOTE

Be careful not to remove the microphone or the microphone grid which can damage the microphone.

2. If you are replacing the windscreen, screw on a new windscreen in a clockwise direction until it fits firmly.
3. To unscrew the microphone, holding the microphone near its base, turn the microphone in a counterclockwise direction until it is removed.

NOTE

Be careful not to remove the upper microphone grid which could damage the microphone.

4. To attach a new microphone, screw the microphone on clockwise until it fits tightly.
 - The following diagram illustrates how to assemble these two devices.

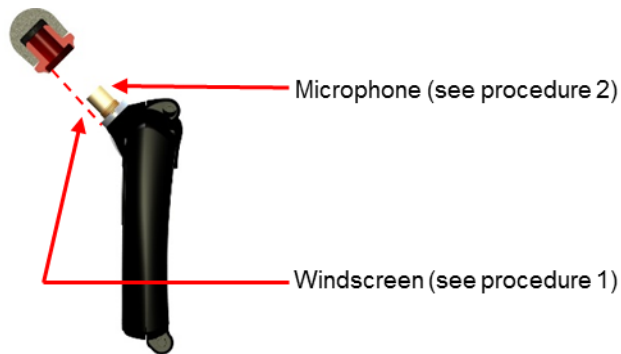

Figure 6-1
Microphone and Windscreen Assembly

CHAPTER 7

Maintenance and Service

Maintenance and Service requires a service technician with skills in both electronics and mechanics. Contact an applications engineer with technical or applications questions according to the Technical Contacts section below.

Technical Contacts

- If you have any difficulty installing the instrument, or if you have technical or application questions about this system, contact an applications engineer at one of the locations listed below.
- If the instrument fails, or if you are returning it for service, visit our website at <http://rma.tsi.com> or contact TSI at:

TSI Incorporated

500 Cardigan Road
Shoreview, MN 55126 USA

Phone: +1-800-680-1220 (USA) or +1 (651) 490-2860

E-mail: technical.services@tsi.com

TSI GmbH

Neuköllner Strasse 4
52068 Aachen
GERMANY

Telephone: +49 241-52303-0

Fax: +49 241-52303-49

E-mail: tsigmbh@tsi.com

Web: www.tsiinc.de

TSI Instruments Ltd.

Stirling Road
Cressex Business Park
High Wycombe, Bucks
HP12 3ST
UNITED KINGDOM

Telephone: +44 (0) 149 4 459200

E-mail: tsiuk@tsi.com

Web: www.tsiinc.co.uk

Returning for Service

Visit our website at <http://rma.tsi.com> and complete the on-line "Service Request" form or call TSI at 1-800-680-1220 (USA) or (651) 490-2860, or 001 651 490-2860 (International) for specific return instructions.

Customer Service will need the following information:

- The instrument model number
- The instrument serial number
- A purchase order number (unless under warranty)
- A billing address
- A shipping address

Use the original packing material to return the instrument to TSI. If you no longer have the original packing material, seal off any ports to prevent debris from entering the instrument and ensure that the display and the connectors on the instrument front and back panels are protected. This instrument is very fragile and must be packed in a manner appropriate for a precision instrument.

APPENDIX A

Specifications

**All specifications are subject to change without notice.

Standards

Meets requirements of:

- ANSI S1.25, IEC61252 Standards for Personal Sound Exposure Meters.
- Lead Free (RoHS compliant).

ANSI S1.25 Class Designation

Acoustic Dosimeter: 2AS-V/V-5 with frequency weighting C, Time constant F, and exchange rates 3 and 4 also available.

A criterion level of 90 dB and a threshold level of 80 dB are used for measurements to OSHA requirements.

Mechanical Characteristics

Housing	Plastic case with black, gray check background and red outlined buttons.
Size	3.5" long x 2.1" wide x .75" thick (without microphone) (88 mm long x 53 mm wide x 19 mm thick)
Weight	2.5 oz. (less mounting device); (70.87 gr)

Electrical Characteristics

Battery	
Runtime	≥ 60 hours of continuous operation at normal operation under reference to environmental conditions when nominal capacity batteries are installed. [~15 hours, if display is turned ON.]
Life cycles	The battery cell should produce ≥ 80% of original runtime after about 250 discharge/charge cycles or 2 years of use.
Type	Lithium Polymer (Flat cell)
Memory capacity	180 hours

Environmental Effects

Stabilization time	The typical time interval needed to stabilize after changes in environmental conditions is 5 minutes for each 10°C change.
Operating Temperature	+14°F to + 122°F (-10°C to + 50°C)
Charging Temperature	On EdgeDock, (dry) “office” conditions 41°F to 104°F (5°C to 40°C)
Storage Temperature	-13°F to + 140°F (-25°C to + 60°C)
Humidity Range	5% to 95% Non-Condensing
Operating Barometric Pressure Range	65 kPa to 108 kPa (19 to 32 inches of Hg) Approximate 3500 m to -600 m elevation relative to sea-level (11500 ft. to -2000 ft.). Field calibration should be performed near intended operating elevation.
Vibration Effects	Applied Vibration of 0.1 g (10 Hz to 500 Hz) can produce an increase of 3.7 dB above the instrument noise floor. (perpendicular to diaphragm) Note this is about 8.3 dB below the linearity range lower limit of 70 dB. There are no limitations on the use of the Edge EG-4P personal sound exposure meter due to vibration.
Magnetic Field Effects	The threshold level (min 70 dB) was not reached with a 4000 A/m magnetic field applied. The sound exposure, after 1 hour in an 60 Hz 80 A/m magnetic field, with an electrically equivalent microphone impedance device is 0.0 Pa ² h, with no cables used or needed.

EMC & ESD Immunity	<p>The sound level at which the personal sound level meter conforms to the Electromagnetic and electrostatic compatibility requirements and test procedures is 85 dBA, with no cables used or needed. On the docking station(s), it also conforms.</p> <p>No degradation of performance following applications of ESD per IEC 61000-6-1 industrial levels. No limitations due to ESD are known.</p> <p>No degradation of performance during application of RF per IEC 61000-4-3 industrial levels.</p>
-------------------------------	--

User Interface

Display

Size: 128 x 96 color OLED graphic

Keypad

4 keys—Up Arrow, Down Arrow, Run/Stop, On/Off Enter

EdgeDock1 and EdgeDock5

EdgeDock1 and EdgeDock5 are powered by a 12-volt charger adapter with international plug adapters. The backside of the Edge slides into the hook of the EdgeDock1 or EdgeDock5 with the mounting clasps rotating to a 90-degree angle (which will rest on a table/work area). Additionally, the EdgeDock1 (or EdgeDock5) are equipped with two single screw slots for wall mounting purposes.

Physical Attributes of EdgeDock1 and EdgeDock5

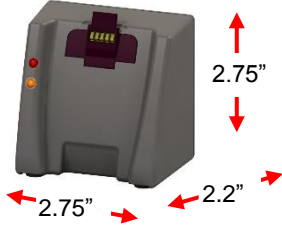
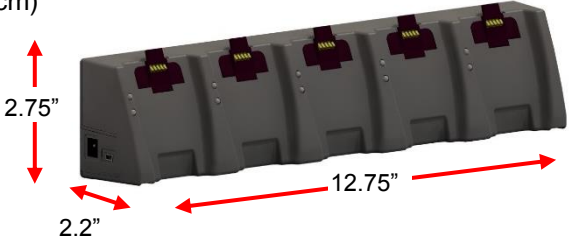
LED amber indicator	Indicates EdgeDock1 or EdgeDock5 is “powered on”. (Lower of the two shown LEDs).
LED Red indicator and LED Green indicator	Signifies status of charging. Flashing red indicates charging. Solid green indicates charging is complete.
Size of EdgeDock1	2.75" x 2.75" x 2.2" (6.99 cm x 6.99 cm x 5.6 cm) 
Size of EdgeDock5	12.75" x 2.2" x 2.75" (32.29 cm x 5.08 cm x 6.99 cm) 

Measurements

Types	
Displayed Data and status indicators	SPL, Average value (Lavg or Leq), Maximum value (Lmx), Minimum value (Lmn), Peak Value (Lpk), Exposure, Run Time, TWA, UL Time

Measurement Parameters and Specs	
Dosimeters	Two dosimeters at once (EG-4P), each with its own assignable profile (via DMS only).
RMS Range	RMS Linear operating range is: 70 to 140 dB
RMS Weighting	A or C weighting
RMS Time Response	Fast or Slow
Frequency Range and tolerance(s)	20 Hz to 12.5 kHz 20, 25, 31.5 ±3dB 40, 50 ±2 dB ≥ 8 kHz +5/-∞ dB

Measurement Parameters and Specs	
Exchange Rate (ER)	3 dB, 4 dB, or 5 dB
Peak Range	110 dB to 143 dB
Peak Weighting	C or Z weighting
Pulse Range @ Tolerance:	1 ms 4 kHz tone-burst: 53 dB @ ±1.5 dB 10 ms 4 kHz tone-burst: 53 dB @ ±0.7 dB 100 ms 4 kHz tone-burst: 53 dB @ ±0.7 dB The shortest tone-burst is 1 ms, tone-bursts are applied with continuous 70 dBA @ 1 kHz
Criterion Levels (Lc)	70 to 90 dB in 1 dB increments
Criterion Duration (Tc) / Projected time	8 Hours, not adjustable in unit. (Reference integration time)
Threshold Level (Lt)	70 to 90 dB in 1 dB increments
Upper Limit (UL) trigger	The upper Limit is triggered at 141 dB. The delay time is less than or equal to 1 second.
Upper Limit Trigger (minimum time)	1/32 sec, plus delay of time response. (F / S)
Integration time duration Limits:	At sound level (L) of 70 to 140 dB the Integration period (t) is 1 sec. to over 10 Hours (@140 dB). This spec is about size and resolution of internal math functions to meet measurement standards and does not limit runtime to 10 hours.
Reference range:	Not Applicable, unit is auto-ranging.
Reference Sound exposure	1 Pa ² ·h
Sound Exposure range	0.01 to 9999.9 Pa ² ·h
Sound Exposure Impulse Tolerance	The typical percentage deviations from the sound exposure indicated, in response to positive-going unipolar pulses and to negative-going unipolar pulses is 0.63 %.
Noise Floor:	≤ 58 dBA
Microphone input tests	Microphone source coupling 6pF / 5.6 Vrms MAX (Use BNC 6pF Input Adapter 053-759)
Microphone Reference Direction	The reference sound-wave direction is perpendicular to the microphone face or 0 degrees incidence angle.

Measurement Parameters and Specs	
Acoustic test method	To determine the relative frequency response the sound exposure meter was suspended from the ceiling using strings with the microphone face perpendicular to the sound source.

(Field) Calibration	
Pre-calibration	When performed, valid prior to the start of the study.
Post-calibration	When performed, valid for the previous study.
Storage	Calibrations for a study are stored in the related study file.
Calibrator requirement	Calibrations should be performed at 114 dB at 1 kHz (Reference SPL & Frequency)
Pressure to Free field	The pressure field to free field correction at 1 kHz is zero.
Calibration Interval	Annual laboratory recalibration is recommended.

Communications
The Edge communicates via the EdgeDock1 and/or the EdgeDock5. Communications is supported via USB cable from the docking station to the PC.

Special Functions	
Security	Key sequence protection through the keypad when running.
Auto-Run	May be programmed via Detection Management Software.
Logging (EG-4P only)	The EG-4P is a dual dosimeter with data logging which includes Lavg or Leq (1/2), Max level, and Peak level.

Edge Block Diagram

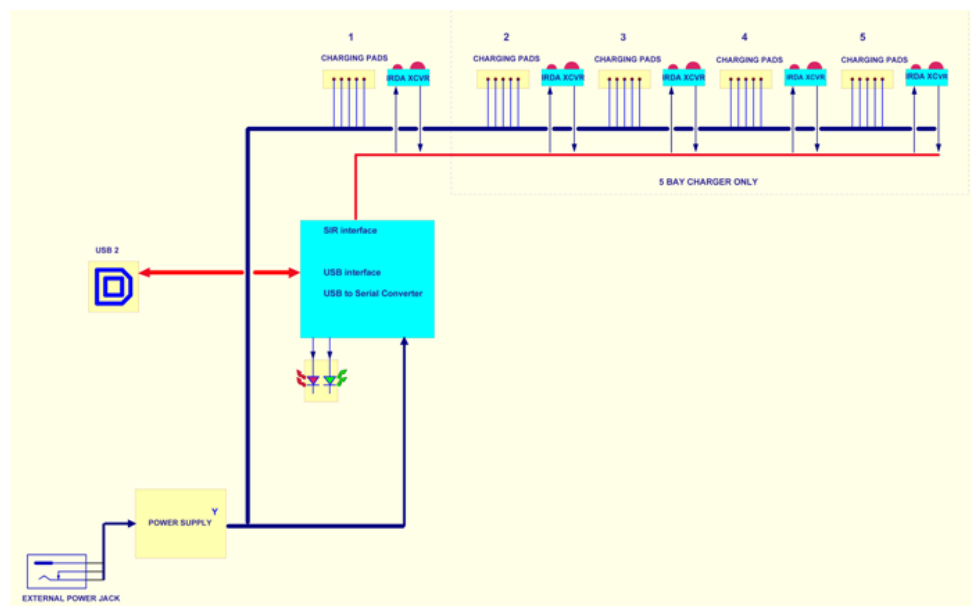
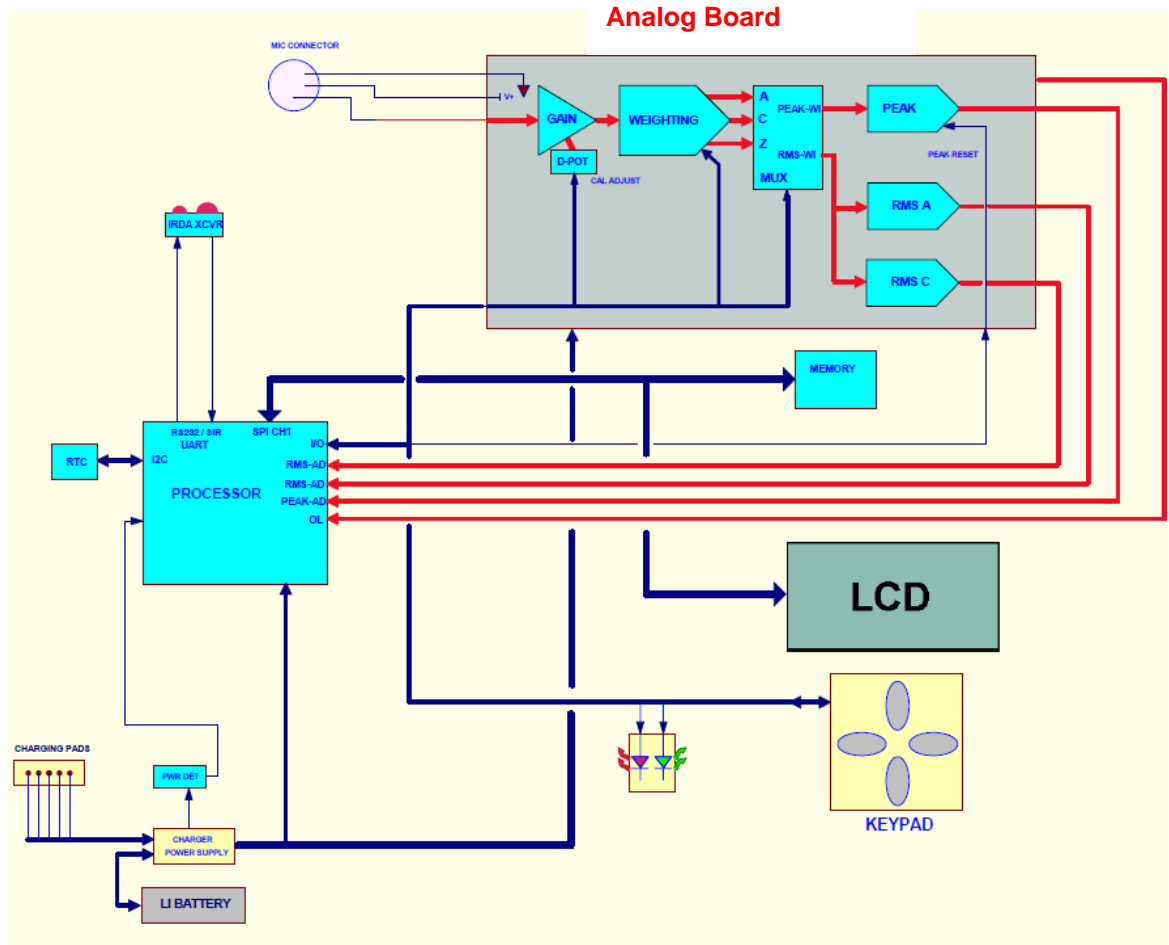

(This page intentionally left blank)

APPENDIX B

Glossary of Terms

Background Noise, effects of

Background noise can cause considerable error in measurement when its level is high relative to the level of a noise source of interest. If you can make measurements both with and without the contribution of a noise source of interest, you can mathematically subtract the background noise from the combined measurement, yielding the level of the noise source of interest alone. The accuracy of this determination improves as the difference between the two measurements increases.

To remove background noise

1. Obtain a measurement that includes the contribution of the noise source of interest (the combined measurement).
2. Make a second measurement under exactly the same conditions as in Step 1 but without the presence of the noise source of interest (the background noise measurement).
3. Determine the decibel difference between these two measurements.
4. Find that difference on the x-axis of the figure below.
5. Find the point on the curve directly above this difference.
6. Read the corresponding value on the y-axis for that point (the correction value).
7. Subtract the correction value from the combined measurement.

Example: Measurements with and without the noise source of interest are 91 dB and 90 dB, respectively. For a difference of 1 dB, the background noise correction value is 7 dB. Therefore, the level for the noise source of interest without the noisy background is 84 dB.

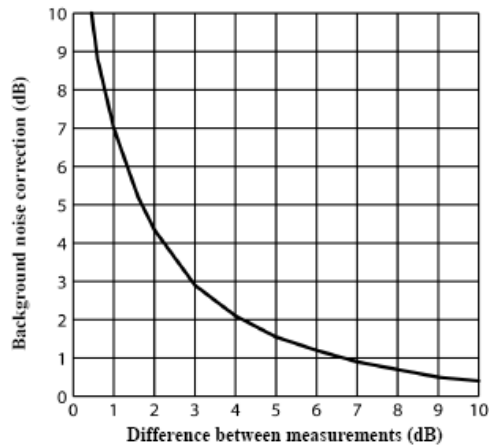

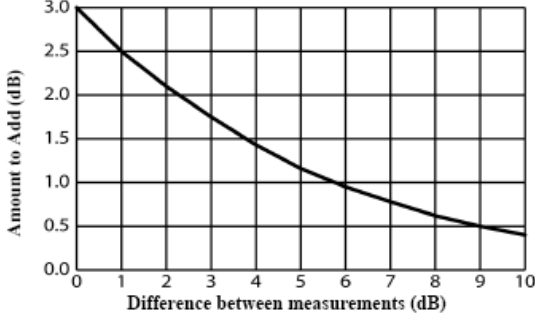
<p>Combining Noise sources</p>	<p>Because sound levels are measured in decibels they cannot be simply added together. A sound level of 90 dB plus 90 dB does not yield 180 dB but rather 93 dB. The procedure for mathematically determining a combined level of sound from independent measurements made for two noise sources is given below.</p> <ol style="list-style-type: none"> 1. Make independent measurements for both noise sources, where each exists without the presence of the other. 2. Determine the decibel difference between these two measurements. 3. Find that difference on the x-axis of the figure below. 4. Find the point on the curve directly above this difference. 5. Read the corresponding value on the y-axis for that point (the Amount to Add). 6. Add this value to the larger of the two measurements. <p>Example: Independent measurements for the two noise sources yielded levels of 90 dB and 91 dB. For a difference of 1 dB, the correction factor taken from the curve below is 2.5 dB. Therefore the combined level when these two sound sources are present in the measurement area at the same time 93.5 dB.</p> 
<p>Crest Factor</p>	<p>Crest Factor is the ratio of the instantaneous peak value of a wave to its RMS value. This is a performance specification of a meter’s ability to process signals that have peaks that are substantially higher than their RMS averages.</p>
<p>Criterion Level (CL)</p>	<p>Criterion level is the average SPL that will result in a 100% dose over the Criterion time, usually 8 hours. The Criterion Level is typically set by a regulating agency, such as OSHA, and is not usually applicable for community noise monitoring. Examples: OSHA mandates the Criterion Level (maximum allowable accumulated noise exposure) to be 90 dB for 8 hours. For an 8-hour sample, an average level (Lavg) of 90 dB will result in 100% dose. For the OSHA HEARING CONSERVATION AMENDMENT, the “action level” is 85 dB for 8 hours. This would result in a 50% dose reading. Note that the Criterion Level has not changed. (If the Criterion Level were changed to 85 dB then an 8-hour average of 85 dB would result in 100% dose.)</p>
<p>Criterion Time</p>	<p>The time over which the Criterion Level is established, generally 8 hours.</p>
<p>Decibel (dB)</p>	<p>Sound Level Meters use the decibel as the unit of measure known as Sound Pressure Level (SPL). SPL uses the ratio between a reference level of 20 microPascals (.00002 Pascals) and the level being measured. $SPL = 20 \log(\text{measured level}/\text{reference level})$. Example: the SPL for 1 Pascal is $20 \log(1 \text{ Pascal}/.00002 \text{ Pascal}) = 94 \text{ dB}$ 20 microPascals (.00002 Pascals) is considered the average threshold of hearing. A whisper is about 20 dB. A normal conversation is typically from 60 to 70 dB, and a noisy factory from 90 to 100 dB. Loud thunder is approximately 110 dB, and 120 dB borders on the threshold of pain.</p>

Dose	Related to the Criterion Level, a dose reading of 100% is the maximum allowable exposure to accumulated noise. For OSHA, 100% dose occurs for an average sound level of 90 dB over an 8 hour period (or any equivalent exposure). By using a TWA reading rather than the average sound level, the time period is no longer explicitly needed. A TWA of 90 dB is the equivalent of 100% dose. The dose will double (halve) every time the TWA increases (decreases) by the Exchange Rate. Example: OSHA uses an Exchange Rate of 5 dB. Suppose the TWA is 100 dB. The dose would double for each 5 dB increase over the Criterion Level of 90 dB. The resulting dose is therefore 400%. If the TWA was instead equal to 80 dB then the dose would halve for each 5 dB below the Criterion Level. The resulting dose would be 25%. When taking noise samples less that the full workday, dose is an easy number to work with because it is linear with respect to time. Example: If a 0.5-hour sample results in 9% dose and the workday is 7.5 hours long, then the dose for the full workday would be a 135% dose ($7.5 / 0.5 \times 9\%$). This is computed making the assumption that the sampled noise will continue at the same levels for the full 7.5-hour workday.
Exchange Rate (ER – also known as the Doubling Rate)	Exchange rate refers to how the sound energy is averaged over time. Using the decibel scale, every time the sound energy doubles, the measured level increases by 3 dB. This is the 3 dB exchange rate that most of the world uses. For every increase of 3 dB in the time weighted average, the measured DOSE would double. Some organizations such as OSHA in the U.S. have argued that the human ear self-compensates for changing noise levels and they felt that the 3 dB exchange rate should be changed to more closely match the response of the human ear. OSHA currently uses a 5 dB exchange rate, which would mean that the reported DOSE would double with every 5 dB increase in the time weighted average. The exchange rate affects the integrated reading Lavg, DOSE, and TWA but does not affect the instantaneous sound level.
Field Calibration (vs. Factory Calibration), pre-calibration, post-calibration	To be sure the dosimeter is functioning within specified tolerance limits, it should be returned to the factory annually for a factory calibration. To verify that the dosimeter is measuring properly during normal use, field calibrations should be performed. Pre-calibration is performed prior to any data being recorded by the dosimeter. During a pre-calibration, the dosimeter level may be adjusted to match the calibrator output level. Post-calibration is a simple verification that the instrument has remained in calibration throughout the measurement period.
Free field setting (microphone)	Measurements made in an area without sound reflections, diffractions and absorptions caused by nearby objects (including the operator). Sound waves are free to spread out continuously, like ripples on a pond, without reflection. When making free field measurements with a dosimeter set up for use as a sound level meter, the microphone is typically pointed directly at the sound source.
Hearing Conservation (HC)	The Occupational Safety and Health Administration (OSHA) and Mine Safety and Health Administration (MSHA) provide regulatory standards for hearing conservation programs. In addition, the American Conference of Governmental Industrial Hygienists (ACGIH) provides industrial standards for hearing conservation programs. http://www.osha.gov/ , http://www.msha.gov/ , http://www.acgih.org/home.htm .
Hertz (Hz)	Unit of vibration frequency in cycles per second.

Lavg (Average Level)	Lavg is the average sound level measured over the run time. This becomes a bit confusing when thresholds are used. Any sound below the threshold is not included in this average. Remember that sound is measured in the logarithmic scale of decibels therefore the average cannot be computed by simply adding the levels and dividing by the number of samples. When averaging decibels, short durations of high levels can significantly contribute to the average level. Example: Assume the threshold is set to 80 dB and the Exchange Rate is 5 dB (the settings of OSHA's Hearing Conservation Amendment). Consider taking a one-hour noise measurement in an office where the A-weighted sound level was typically between 50 dB and 70 dB. If the sound level never exceeded the 80 dB threshold during the one hour period, then the Lavg would not indicate any reading at all. If 80 dB was exceeded for only a few seconds due to a telephone ringing near the instrument, then only those seconds will contribute to the Lavg resulting in a level perhaps around 40 dB (notably lower than the actual levels in the environment).
LEP,D	Daily personal noise exposure level.
Leq (Equivalent Level)	The true equivalent sound level measured over the run time. The term Leq is functionally the same as Lavg except that it is only used when the Exchange Rate is set to 3 dB and the threshold is set to none.
Logging	(Also called Data Logging.) Certain measurements, such as average level (Lavg) and maximum level (max), can be recorded by the dosimeter at regular intervals. For example: A dosimeter is set to log Lavg and max at one minute logging intervals. If the dosimeter runs for one hour, then it would log 60 Lavg results and 60 max levels. You would be able to see the average and maximum levels for each minute of the one hour run time.
Maximum Level (LMAX)	The highest sampled sound level during the instrument's run time allowing for the unit's Response Time setting (Fast or Slow).
Measurement Range	The decibel range within which the unit's measurements are valid.
Minimum Level (Lmin)	The lowest sampled sound level during the instrument's run time allowing for the unit's Response Time setting (Fast or Slow).
Noise Floor	In a "Perfectly Quiet" room, the Noise Floor is the lowest reading that can be reached. To minimize additive noise errors, measurements should always be at least 5 dB above the Noise Floor to be valid. The Noise Floor can cause inaccurate measurements at low measurement levels.
Peak Level	Peak is the highest instantaneous sound level that the microphone detects. Unlike the Max Level, the peak is detected independently of the unit's Response Time setting (Fast or Slow). Example: The peak circuitry is very sensitive. Test this by simply blowing across the microphone. You will notice that the peak reading may be 120 dB or greater. When taking a long-term noise sample (such as a typical 8-hour workday sample for OSHA compliance), the peak level is often very high. Because brushing the microphone over a shirt collar or accidentally bumping it can cause such a high reading, you must be careful of placing too much emphasis on the reading.
PEL (Permissible Exposure Level)	The A-weighted sound level at which exposure for a Criterion Time, typically eight hours, accumulates a 100% noise dose.
Projected Time	The variable amount of time used to make a projected dose calculation from an actual dose measurement.

Random Incidence (microphone)	This only applies to Class/Type 1 microphones. Measurements made in an area where sound waves are coming from all directions, including reflections and diffractions. When the dosimeter is being used as a sound level meter in an area where reflections and diffractions from nearby objects are present, use the Random Incidence Corrector with the microphone, and angle the microphone at approximately 70 degrees. Most personal noise dosimetry applications do not require the random incidence corrector, since they are not measured with a Class/Type 1 microphone.
Response Time	The response determines how quickly the unit responds to fluctuating noise. Fast has a time constant of 125 milliseconds. Slow has a time constant of 1 second. Example: Typically, noise is not constant. If you were to try to read the sound level without a response time, the readings would fluctuate so much that determining the actual level would be extremely difficult. Using a response of slow or fast simply smooths the noise fluctuation and makes the sound level easier to work with. While the terms slow and fast have very specific meanings (time constraints), they work very much as you would expect. The fast response would result in a more fluctuating sound level reading than would the slow response. The OSHA regulations require the slow response.
RMS (Root Mean Square)	The RMS voltage of a signal is computed by squaring the instantaneous voltage, integrating over the desired time, and taking the square root. Simply put, the RMS values are the results from the dosimeter with the response time and weighting settings taken into account.
SEL/Lxe (Sound Exposure Level)	The sound exposure level averages the sampled sound over a one second period. Assuming the sampled run time to be greater than one second, SEL is the equivalent one-second noise that would be equal in energy to the noise that was sampled. SEL is typically measured using a 3 dB exchange rate without a threshold. SEL is not used by OSHA. Example: Suppose you wanted to measure in a location next to railroad tracks, which also happened to be in the takeoff path of an airport. A train passes by taking 10 minutes with an average sound level of 82 dB. A jet passes overhead taking 45 seconds with an average level of 96dB. Which of these events results in more sound energy? You can answer the question by comparing their SEL readings, which compress each event into an equivalent one-second occurrence. SEL for the train = 109.7 dB, SEL for the jet = 112.5 dB.
Threshold	The threshold affects the Lavg, TWA, and Dose measurements. All sound below the threshold is considered nonexistent noise for the averaging and integrating functions. The threshold does not affect measurements in the sound level mode. OSHA uses two different thresholds. The original Occupational Noise Exposure Standard (1971) used a 90 dB threshold and called for engineering controls to reduce the noise levels if the eight-hour TWA was greater than 90 dB. The Hearing Conservation Amendment (1983) uses an 80 dB threshold and calls for a hearing conservation program to be put in place if the eight-hour TWA exceeds 85 dB (50% dose). The Hearing Conservation Amendment is the more stringent of the two rulings and is what most US industrial users are concerned with. Example: With an 80 dB threshold, suppose you placed a 79 dB calibrator on the unit for a period of time. Because all of the noise is below the threshold, there would be no average (you can think of it as an average of 0 dB). If the calibrator were 80 dB instead, then the average would be 80 dB. On histogram printouts, typically 1 minute (or other specified increment) averages are printed. Because real noise fluctuates, it is quite possible to have an average level below the threshold. This also applies for the overall Lavg.

<p>TWA (Time Weighted Average)</p>	<p>The time weighted average always averages the sampled sound over an 8-hour period. TWA starts at zero and grows. The TWA is less than the Lavg for a duration of less than eight hours, exactly equal to the Lavg at eight hours, and grows higher than Lavg after eight hours. TWA represents a constant sound level lasting eight hours that would result in the equivalent sound energy as the noise that was sampled. Example: Think of TWA as having a large 8-hour container that stores sound energy. If you run a dosimeter for 2 hours, your Lavg is the average level for those 2 hours - consider this a smaller 2-hour container filled with sound energy. For TWA, take the smaller 2-hour container and pour that energy into the larger 8 hour TWA container. The TWA level will be lower. Again, TWA is ALWAYS based on the 8-hour container. When measuring using OSHA's guidelines, TWA is the proper number to report provided that the full work shift was measured. Example: If the work shift is 6.5 hours long then measure for the entire 6.5 hours. TWA is the correct level to report to OSHA. It does not have to be modified.</p>
<p>Weighting (A, C, Z, etc.)</p>	<p>"A", "B", "C", "Z" and LINEAR are the standard weighting networks available. These are frequency filters that cover the frequency range of human hearing (20 Hz to 20 kHz). "A" weighting is the most commonly used filter in both industrial noise applications (OSHA) and community noise regulations. "A" weighted measurements are often reported as dBA. The "A" weighted filter attempts to make the dosimeter respond closer to the way the human ear hears. It attenuates the frequencies below several hundred hertz as well as the high frequencies above six thousand hertz. "B" weighting is similar to "A" weighting but with less attenuation. The "B" weighting is very seldom, if ever, used. The "C" weighting provides a fairly flat frequency response with only slight attenuation of the very high and very low frequencies. "C" weighting is intended to represent how the ear perceives sound at high decibel levels and is often used as a "flat" response when LINEAR is not available. "C" weighted measurements are often reported as dBC. "Z" is zero weighting, with no weighting across the frequency range of human hearing. LINEAR is thought of as having a flat frequency response curve over the entire measurement frequency range. LINEAR is most commonly found on upper model sound level meters and is typically used when performing octave band filter analysis.</p>
<p>Upper Limit (UL)</p>	<p>A type of measurement parameter setting in which the user selects a certain decibel level. The dosimeter will then record the amount of time that the sound level was at or greater than the preset level. This time is then recorded as "UL Time"</p>
<p>Windscreen</p>	<p>A windscreen is a covering for the microphone that reduces disturbances caused by wind and direct contact with other surfaces. The windscreen is placed over the microphone when taking measurements to help prevent false high readings due to wind blowing across the microphone or objects (hair, clothing, etc.) brushing against the microphone. The windscreen will also help protect the microphone from dust and debris.</p>

APPENDIX C

Measurement Equations

The following equations are used in the Edge calculations. Some of the terms used in these equations are explained above in the "[Glossary of Terms](#)" appendix.

$$DOSE = \frac{100}{TC} \left[\int_0^{RTIME} 2^{(LS-CL)/(ER)} dt \right] \%$$

$$Prd_{\times hours} = DOSE \times \frac{Pr t}{RTIME} \%$$

$$Prd_{8 hours} = DOSE \times \frac{TC}{RTIME} \%$$

$$L_{AVG} = ER \left[\log_2 \int_0^{LS/3.01} 2^{LS/3.01} dt - \log_2(RTIME) \right] dB$$

(This page intentionally left blank)

APPENDIX D

Radio Approvals Page

Europe

This device meets the requirements of the Telecommunications Directive RED.

2014/53/EU: EN 300 328 v2.2.1
EN 301 489-1 v2.2.0
EN 301 489-17 v3.1.1
EN 62311:2008

USA

Contains Transmitter Module FCC ID: VPYLBZFY

This device complies with part 15 of the FCC Rules. Operation is subject to the following two conditions: (1) This device may not cause harmful interference, and (2) this device must accept any interference received, including interference that may cause undesired operation.

FCC Caution

Changes or modifications not expressly approved by the party responsible for compliance could void the user's authority to operate the equipment.

This transmitter **MUST NOT** be co-located or operated in conjunction with any other antenna or transmitter.



W A R N I N G

This equipment complies with FCC radiation exposure limits set forth for an uncontrolled environment and meets the FCC radio frequency (RF) Exposure Guidelines. This equipment has very low levels of RF energy that are deemed to comply without testing of specific absorption ratio (SAR).

Industry Canada (IC)



WARNING

This device complies with Industry Canada license-exempt RSS standard(s). Operation is subject to the following two conditions: (1) this device may not cause interference, and (2) this device must accept any interference, including interference that may cause undesired operation of the device.

AVERTISSEMENTS

Le présent appareil est conforme aux CNR d'Industrie Canada applicables aux appareils radio exempts de licence. L'exploitation est autorisée aux deux conditions suivantes : (1) l'appareil ne doit pas produire de brouillage, et (2) l'utilisateur de l'appareil doit accepter tout brouillage radioélectrique subi, même si le brouillage est susceptible d'en compromettre le fonctionnement.



WARNING

This equipment complies with IC radiation exposure limits set forth for an uncontrolled environment and meets RSS-102 of the IC radio frequency (RF) Exposure rules. This equipment has very low levels of RF energy that are deemed to comply without testing of specific absorption ratio (SAR).

AVERTISSEMENTS

Cet équipement est conforme aux limites d'exposition aux rayonnements énoncées pour un environnement non contrôlé et respecte les règles d'exposition aux fréquences radioélectriques (RF) CNR-102 de l'IC. Cet équipement émet une énergie RF très faible qui est considérée conforme sans évaluation du débit d'absorption spécifique (DAS).

Bluetooth Compliance:

Bluetooth Declaration ID: D046666

Index

A

- Attaching
 - charger adapter with plug adapter, 2-6
 - dosimeter, 4-2
- Auto run
 - screen, 3-14
 - setting, 3-13
- Average sound level, 3-4

B

- Background noise, effects of, B-1
- Battery
 - checking, 4-2
 - checking power, 4-2
- Battery charge status, 4-8
- Battery indicator icon, 2-2, 4-3
- Battery indicators, 4-3
- Block diagram, A-7
- Bluetooth compliance, D-2
- Bluetooth declaration, D-2

C

- C-A enable, 3-10
- Calibration, 4-3, 4-4, A-6, B-3
- Caution
 - description, xii
 - description of symbol, xii
 - symbol, xii
- Changing ranges, 5-6
- Charge contacts, 2-6
- Charger adapter, 2-6
- Charging
 - Battery, 2-5
- Charging dosimeter, 2-7
- Charging indicator, 2-6
- Checking battery power, 4-2
- Checking equipment, 2-1
- Combining noise sources, B-2
- Communicating, 3-7
 - Edge Dock, 2-5
- Communications, A-6
- Connecting dosimeter to computer, 3-7
- Crest factor, B-2
- Criterion level, 3-11, B-2
- Criterion time, B-2
- Customizing display view, 3-3
- Customizing set-up parameters in DMS, 3-9

D

- Data finder page, 5-3, 5-4
- Decibel, B-2

- Definition of data log value, 3-4
- Definition of data log view, 3-4
- Detection management software, 1-2
- Display, 2-4
- Display screen, 3-12
- Display setting, 3-11
- Display view
 - customizing, 3-3
- DMS, 1-2, 2-1, 2-5
 - customizing set-up parameters, 3-9
 - data finder page, 5-3, 5-4
 - dosimeter setting, 3-9
 - downloading data, 5-1
 - loading, 2-5
 - logging, 3-3
 - noise studies, 3-1
 - panel layout view, 5-5
 - report view, 5-4
 - reporting, 3-2
 - retrieve data button, 3-1
 - setting up Edge, 3-1
 - setup data button, 3-1
 - start screen, 5-2
 - summary data, 3-2
 - time history, 3-2
 - viewing data, 5-3
 - viewing studies, 5-1
 - views, 3-3
 - what data is stored, 3-2
- Docking station, 2-5, 3-7
 - components, 2-6
- Dose, 3-5, B-3
- Dose indicator LED, 3-10
- Dosimeter
 - attaching, 4-2
 - calibration, 4-3
 - charging, 2-7
 - connecting to computer, 3-7
 - definition, 3-4
 - locking, 4-9
 - operation, 1-2, 4-1
 - processes, 1-2
 - resetting, 4-5
 - securing during run, 4-9
 - setting, 3-9
 - setting contrast, 4-6
 - storage, 2-9
 - typical session, 4-1
 - unlocking, 4-9
 - views, 3-4
 - virtual, 1-6
- Dosimetry, 1-1
- Doubling rate, B-3
- Down arrow, 2-4

- Download, 3-7
- Downloading data, 5-1

E

- Edge
 - positioning, 4-2
 - Edge Dock
 - new hardware wizard, 3-8
 - Edge retrieve data button, 3-1
 - Edge setup data button, 3-1
 - EdgeDock1, 2-1, 2-6, 5-1
 - charge contacts, 2-5, 2-6
 - charging indicator, 2-5, 2-6
 - components, 2-6
 - physical attributes, A-4
 - power connector, 2-5, 2-6
 - power indicator, 2-5, 2-6
 - powering, 2-7
 - specifications, A-3
 - USB connector, 2-5, 2-6
 - EdgeDock1 and EdgeDock5, 3-7
 - EdgeDock5, 2-1, 2-6
 - charge contacts, 2-6
 - charging indicator, 2-6
 - components, 2-6
 - physical attributes, A-4
 - power connector, 2-6
 - power indicator, 2-6
 - powering, 2-7
 - specifications, A-3
 - USB connector, 2-6
 - EG-4P, 1-6
 - memory storage, 3-6
 - EG-4P model, A-6
 - Electrical characteristics, A-2
 - Enter, 2-4
 - Environmental effects, A-2
 - Equipment
 - checking, 2-1
 - ESD protection, xii
 - European symbol for non-disposable item, xi
 - Exchange rate, 3-11, B-3
- ## F
- FCC caution, D-1
 - Firmware update, 3-14
 - screen, 3-15
 - Free field setting, B-3
- ## G
- Getting help, xiii
 - Getting started, 2-1
 - Glossary, B-1

H

Hearing conservation, B-3
Heartbeat, 6-1
Heartbeat enable, 3-10
Help, xiii
Hertz, B-3

I–J

Indicators on display, 4-8
 battery charge status, 4-8
 overload, 4-8
 run, 4-8
 stop, 4-8
Introduction, 1-1

K

Keypad, 2-4

L

Labels, xi
Lavg, B-4
LED indicator, 2-2, 2-3, 2-4
 disable/enable, 6-1
 flashing amber light, 2-3
 flashing green light, 2-3
 flashing red, 2-3
Lep,d, B-4
Leq, B-4
Lmin, B-4
Locking, 4-9
 about, 4-9
logging, 3-3
Logging, A-6, B-4

M

Maintenance, xi, 4-2, 7-1
Maximum Level, B-4
Maximum sound level, 3-4, 3-6
Measurement descriptors/variants,
 3-6
Measurement equations, C-1
Measurement parameters, A-4
Measurement range, B-4
Measurement view, 2-2, 4-8
Measurements, A-4
Mechanical characteristics, A-1
Memory storage symbol, 3-6
Microphone, 2-4
 replacing, 6-1
Minimum sound level, 3-4, 3-6
Model EG-4P, 1-6, 2-1
Mounting docking station, 2-8
Moving graph, 5-6

N

Navigation, 2-3
New hardware wizard, 3-8
Noise dosimeter, 1-2
Noise floor, B-4
Noise studies, 3-1

O

On/Off, 2-4
Options menu, 4-5, 4-6
Overload, 4-8

P

Packing instructions, 7-2
Panel layout view, 5-5
 add panel, 5-5
 adding labels, 5-6
 arrange panel, 5-5
 changing ranges, 5-6
 customizing chart colors, 5-6
 customizing x or y axis font type,
 5-6
 data panel, 5-5
 exporting data to xls file, 5-6
 moving graph, 5-6
 quick tips, 5-6
 saving layout, 5-6
 screen, 5-5
 work items, 5-5
Parameter setup screen, 1-6
Peak level, 3-4, 3-6, B-4
Peak weighting, 3-10
PEL, B-4
Plug adapter, 2-6
Power
 turn off, 2-4
 Turn on, 2-2
Power connector, 2-6
Power indicator, 2-6
Power off, 2-4
Projected time, 3-10, B-4

Q

Quick help list for running a study,
 4-1

R

Radio approvals
 Europe, D-1
 FCC caution, D-1
 Industry Canada, D-2
 USA, D-1
Radio approvals page, D-1
Random incidence, B-5
Range of sound, 1-3
Repair, xi
Report view, 5-4
Resetting, 4-5
 from keypad, 4-5
Response, 3-10
Response level, 3-5
Response time, B-5
Retrieve data, 3-7
Returning for service, 7-2
RMS, B-5
RMS weighting, 3-11
Run, 2-4
Run indicator, 4-7

Run mode, 4-8
Run time, 3-5
Running a study
 overview, 4-1
Running studies, 4-7

S

Safety, xi
Saving configurations, 3-15
Saving setups screen, 3-16
Security setting, 3-12
 screen, 3-13
SEL/Lxe, B-5
Sending configurations, 3-15
Serial number label, xi
Service, 7-1
Service policy, vi
Setting configurations, 3-15
Setting up Edge via DMS, 3-1
Setup data, 3-7
Setup name, 3-11
Sound exposure level, 3-5
Sound pressure, 1-3
Sound pressure level, 3-4, 3-6
Sound range, 1-3
Special functions, A-6
Specifications, A-1
Splash screen, 2-2
Standards, 1-3
Starting run, 4-7
Stop, 2-4
Stop mode, 4-8
Stopping a study, 4-7
Stretching graph, 5-6
Summary data, 3-2
Symbol
 battery power clock, 3-6
 calendar, 3-6
 memory storage, 3-6

T

Technical contacts, 7-1
Telecommunications directive, D-1
Threshold, B-5
Threshold enable, 3-11
Threshold enabled, 6-1
Time history, 3-2
 chart, 3-2
Time-weighted average, 3-5
Trademarks, vi
TWA, B-6

U

Universal charger adapter, 2-1
Unlock mode, 4-9
Unlocking, 4-9
Up arrow, 2-4
Upper limit, 3-5, 3-11, B-6
USB cable, 2-1, 3-7
USB connector, 2-6

User interface
display, A-3
keypad, A-3

V

View, 2-2
Viewing data, 5-3
Viewing measurements on display,
4-8

Viewing studies in DMS, 5-1
Views, 3-3
Virtual dosimeters, 1-6

W-X-Y-Z

Warning, xi
description, xii
description of symbol, xii
symbol, xii

Warranty, v
Weighting, 3-5
Weighting (A, C, Z, etc.), B-6
Windscreen, 2-1, 2-4, 4-2, B-6
replacing, 6-1



TSI Incorporated – Visit our website www.tsi.com for more information.

USA	Tel: +1 800 680 1220	India	Tel: +91 80 67877200
UK	Tel: +44 149 4 459200	China	Tel: +86 10 8219 7688
France	Tel: +33 1 41 19 21 99	Singapore	Tel: +65 6595 6388
Germany	Tel: +49 241 523030		

P/N 6013118 Rev. A

©2019 TSI Incorporated

Printed in U.S.A.

